

FleetPC-4-C

In-Vehicle Computing

User's Manual

Version 1.1

Document Name	FleetPC-4-C User Manual		Document No.	UM2015312010
Version	1.1		Date	Feb. 3, 2015
Reversion History :				
Reversion		Date	Notes	Author(s)
From	To			
	1.0	Feb. 3, 2015	Initial document issued	Stanley Chou

CarTFT.com e.K.

User Manual

Copyright

©2009 by CarTFT.com e.K. All Rights Reserved.

No part of this publication may be reproduced, transcribed, stored in a retrieval system, translated into any language, or transmitted in any form or by any means such as electronic, mechanical, magnetic, optical, chemical, photocopy, manual, or otherwise, without prior written permission from CarTFT.com e.K.

Other brands and product names used herein are for identification purposes only and may be trademarks of their respective owners.

Disclaimer

CarTFT.com e.K. shall not be liable for any incidental or consequential damages resulting from the performance or use of this product.

CarTFT.com e.K. makes no representation or warranty regarding the content of this manual. Information in this manual had been carefully checked for accuracy; however, no guarantee is given as to the correctness of the contents. For continuing product improvement, CarTFT.com e.K. reserves the right to revise the manual or make changes to the specifications of this product at any time without notice and obligation to any person or entity regarding such change. The information contained in this manual is provided for general use by customers.

This device complies to Part 15 of the FCC Rules. Operation is subject to the following two conditions:

1. This device may not cause harmful interference.
2. This device must withstand any background interference including those that may cause undesired operation.

Safety Information

Read the following precautions before setting up a CarTFT.com e.K. Product.

Electrical safety

- To prevent electrical shock hazard, disconnect the power cable from the electrical outlet before relocating the system.
- When adding or removing devices to or from the system, ensure that the power cables for the devices are unplugged before the signal cables are connected. If possible, disconnect all power cables from the existing system before you add a device.
- Before connecting or removing signal cables from the motherboard, ensure that all power cables are unplugged.
- Seek professional assistance before using an adapter or extension cord. These devices could interrupt the grounding circuit.
- Make sure that your power supply is set to the correct voltage in your area. If you are not sure about the voltage of the electrical outlet you are using, contact your local power company.
- If the power supply is broken, do not try to fix it by yourself. Contact a qualified service technician or your retailer.

Operation safety

- Before installing the motherboard and adding devices on it, carefully read all the manuals that came with the package.
- Before using the product, make sure all cables are correctly connected and the power cables are not damaged. If you detect any damage, contact your dealer immediately.
- To avoid short circuits, keep paper clips, screws, and staples away from connectors, slots, sockets and circuitry.
- Avoid dust, humidity, and temperature extremes. Do not place the product in any area where it may become wet.
- Place the product on a stable surface.
- If you encounter technical problems with the product, contact a qualified service technician or your retailer.

CAUTION

Incorrectly replacing the battery may damage this computer. Replace only with the same or its equivalent as recommended by CarTFT.com e.K. Dispose used battery according to the manufacturer's instructions.

Technical Support

Please do not hesitate to call or e-mail our customer service when you still cannot fix the problems.

E-mail : sales@cartft.com

Website : www.CarTFT.com

TABLE OF CONTENTS

Page #

1.0 Introduction	8
1.1 Model Specification	8
1.2 VBOX-3120 Illustration (MB, System)	9
1.3 Architecture	12
1.4 Principal Component Specification	12
2.0 Internal Connector Specification	15
2.1 VGA Connector	15
2.2 USB Connector (USB2)	16
2.3 USB Connector (USB3)	17
2.4 GPIO Connector	18
2.5 UART and GPIO Connector	19
2.6 LED Connector	20
2.7 COM Connector (COM1)	21
2.8 COM Connector (COM2)	22
2.9 COM Connector (COM3)	24
2.10 COM Connector (COM4)	25
2.11 AUDIO Connector	26
2.12 SATA Connector (SATA1)	27
2.13 SATA Connector (SATA2)	28
2.14 Mini PCI-E Connector (MINICARD1)	29
2.15 Mini PCI-E Connector (MINICARD2)	32
2.16 Power Input Connector	34
2.17 SATA Power Connector (SPWR1)	35
2.18 SATA Power Connector (SPWR2)	36
3.0 External Connector Specification	38
3.1 USB Connector	38
3.2 LAN Connector (LAN1)	39
3.3 LAN Connector (LAN2)	40
3.4 DVI-I Connector	41
3.5 HDMI Connector	42

3.6 Audio Connector	43
3.6 Power Input Connector.....	44
3.7 DIO Connector.....	46
4.0 System Installation.....	48
4.1 System Introduction.....	48
4.2 Opening Chassis.....	49
4.3 Installing Memory.....	51
4.4 Installing HDD / SSD.....	53
4.5 Installing MINI PCIe Expansion Card.....	55
4.6 Installing MINI PCIe Expansion Card.....	57
4.7 Installing SIM Card.....	59
4.8 Installing Battery Module.....	61
5.0 System Resource.....	63
5.1 Ignition Power Management Quick Guide.....	63
6.0 BIOS.....	67
6.1 Enter The BIOS.....	67
6.2 Main.....	69
6.3 Advanced.....	70
6.4 Chipset.....	76
6.5 Boot.....	79
6.6 Security.....	81
6.7 Exit.....	82
7.0 Packing List.....	84
7.1 Packing List.....	84

1.0 INTRODUCTION

1.0 INTRODUCTION

1.1 Model Specification



System	
CPU	Intel Gen4 Dual Core 2980U 1.6 GHz
Memory	1 x DDR3L-1600 SO-DIMM up to 8GB
Graphics	Intel HD Graphics
ATA	2 x Serial ATA 2.0 Ports with 6Gb/s HDD Transfer Rate
LAN Chipset	2 x Intel i210-AT Gigabit Ethernet
Watchdog	1 ~ 255 level reset
I/O	
Serial Port	Suupport 1 x RS-232 (COM1 with RS-232/422/485)
USB Port	3 x USB 2.0 ports
LAN	2 x RJ45 ports for GbE
Video Port	1 x HDMI and DVI-I
GPIO Port	Support 2 In and 2 Out (12V / 100mA)
Audio	Mic-in/Line-out
Expansion Bus	3 x Mini-Card Slots
SIM Card Socket	2 x SIM Card sockets supported onboard with eject
Antenna	4 x SMA-type External Antenna Connectors for WLAN / UMTS / GSM / GPRS / GPS / Bluetooth

Storage	
Type	1 x 2.5" drive bay for SATA Type Hard Disk Drive / SSD 1 x SATA DOM
Power Management	
Power Input	9V - 36V DC Power Input
Power Management	Vehicle Power Ignition for Variety Vehicle
Power Off Control	Power off Delay Time Setting by Software, Default is 5 Mins
Backup Battery	Internal Battery Kit for 10 Mins Operating (Optional)
Qualification	
Certifications	CE, FCC Class A, eMark Compliance
Environment	
Operating Temp.	-40 ~ 70°C (SSD), ambient w/ air
Storage Temp.	-40 ~ 80°C
Relative Humidity	5 ~ 90% (non-condensing)
Vibration (random)	2.5g@5~500 Hz with SSD
Vibration Operating	MIL-STD-810F, Method 514.5, Category 20, Ground Vehicle-Highway
Truck Storage	MIL-STD-810F, Method 514.5, Category 24, Integrity Test
Shock	Operating: MIL-STD-810F, Method 516.5, Procedure I, Trucks and semi-trailers=15G(11ms) with 80G with SSD
Crash Hazard	MIL-STD-810F, Method 516.5, Procedure V, Ground equipment=100
Mechanical	
Construction	Aluminum alloy
Mounting	Supports both of wall-mount/VESA-mount
Weight	1.406g
Dimensions	182 x 167.6 x 52 mm

1.2 FleetPC-4-C Illustration (MB, System)

Main Board

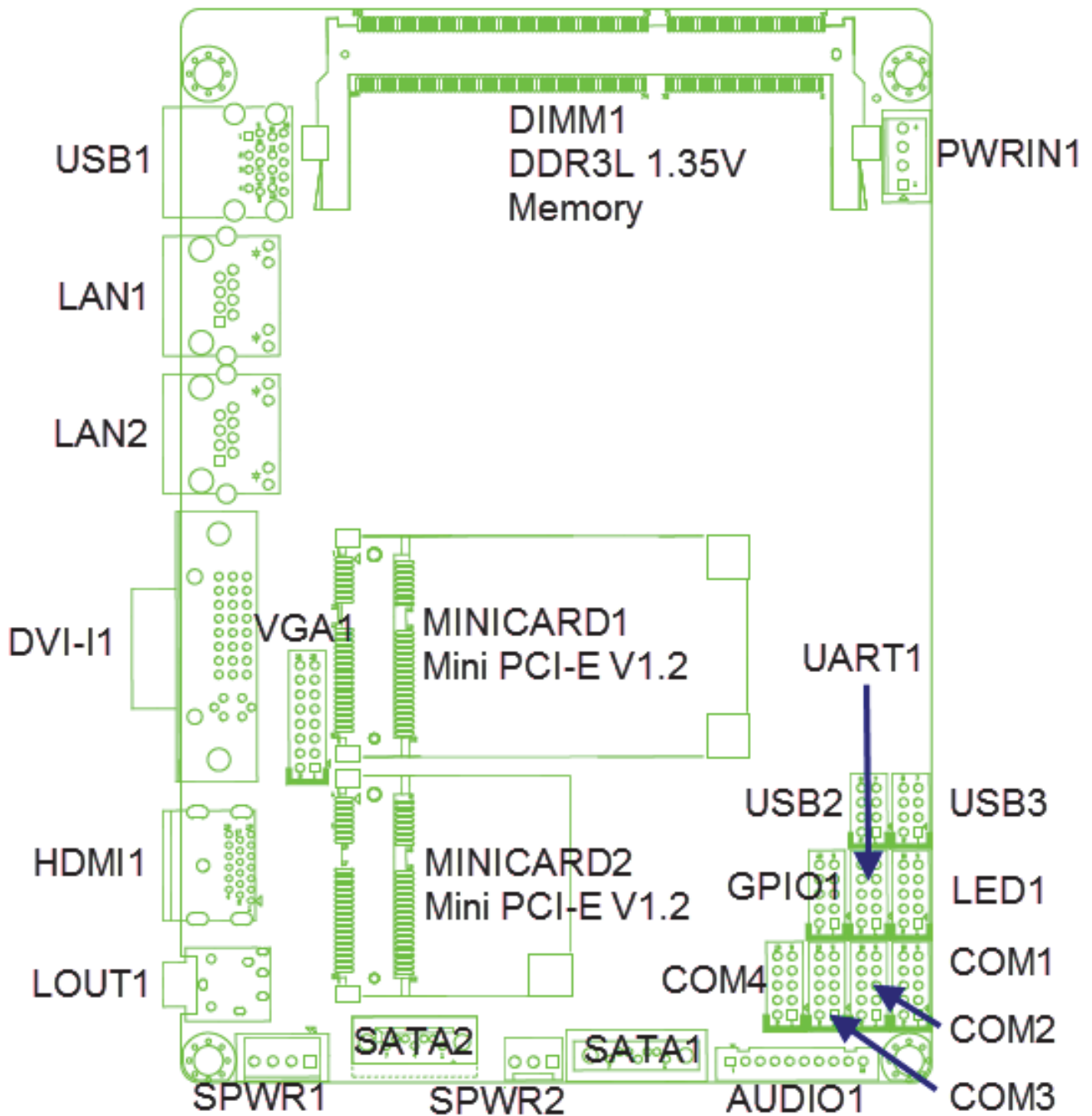

System

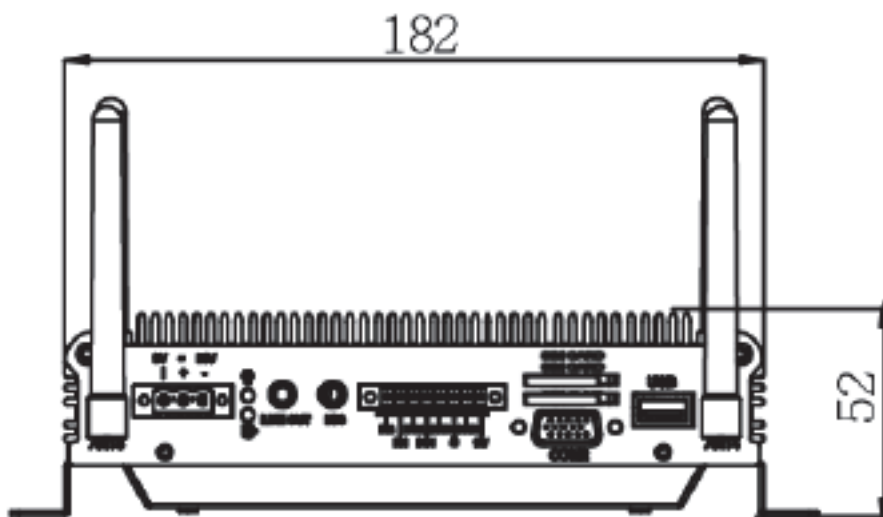
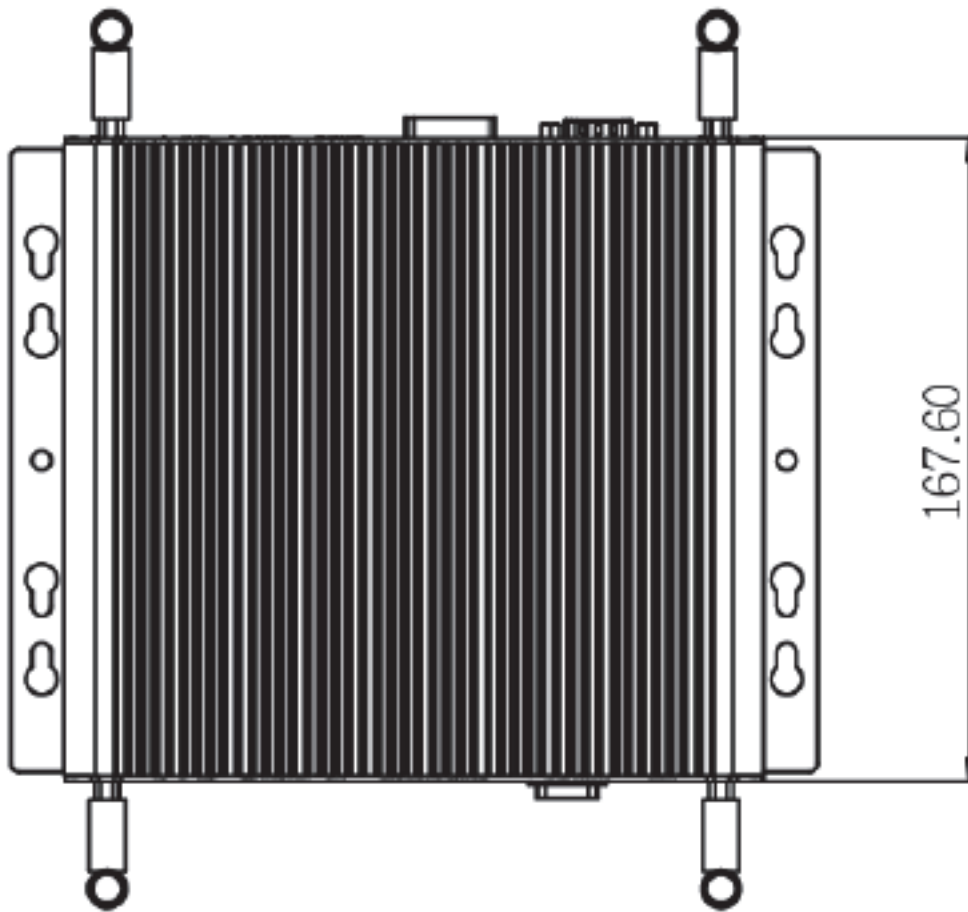

1.3 Architecture

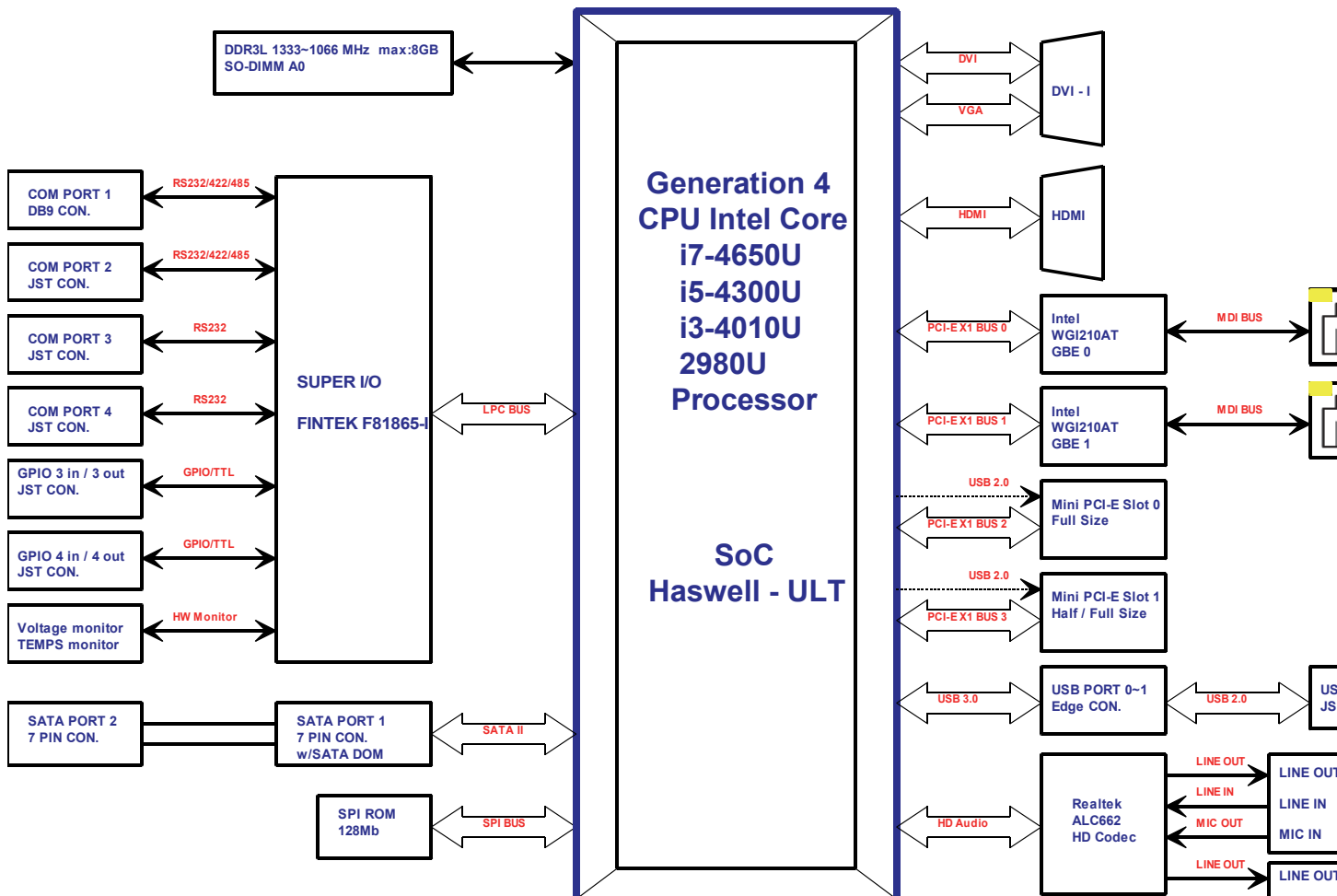

1.4 Principal Component Specification

CPU

Chip	Description						
Intel	1. Power Consumption:						
	Symbol	Processor Number	Core Frequency / GHz	Thermal Design Power	Unit	Tj min (°C)	Cache
	TDP	2980U	1.6	15	W	100	2M
		i3-4010U	1.7	15	W	100	3M
		i5-4300U	1.9-2.9	15	W	100	3M
i7-4650U		1.7 – 3.3	15	W	100	4M	

2.0
INTERNAL CONNECTOR
SPECIFICATION

2.0 INTERNAL CONNECTOR SPECIFICATION

2.1 VGA Connector

Connector size	2 X 8 = 16 Pin			
Connector type	JST-2.0mm-M-180			
Connector location	VGA1			
Connector pin definition	Pin	Signal	Pin	Signal
	1	RED	2	GREEN
	3	BLUE	4	NC
	5	CER DET	6	GND
	7	GND	8	GND
	9	+5V	10	GND
	11	NC	12	DAC SDA
	13	HSYNC	14	VSYNC
	15	DAC SCL	16	NC

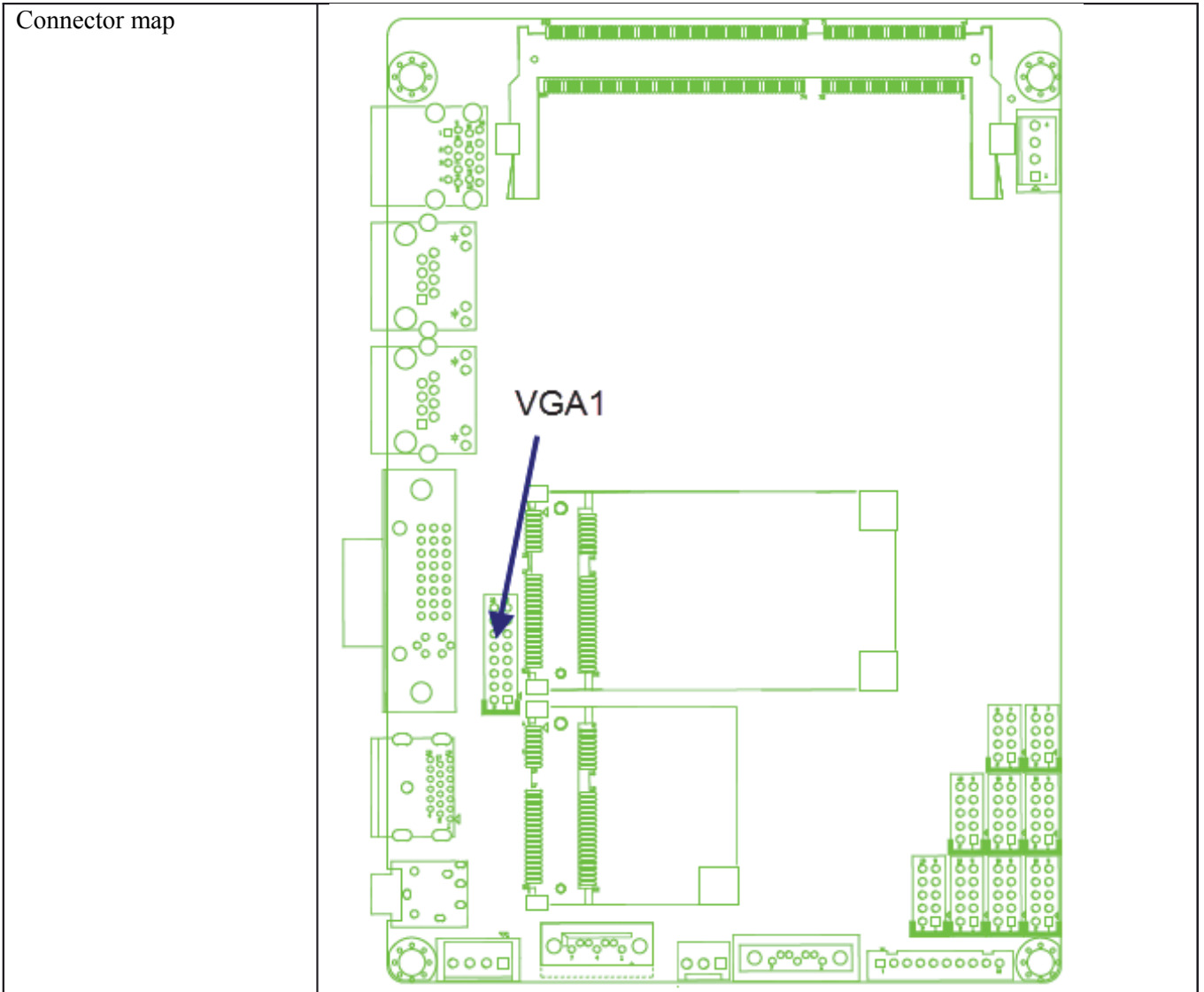

2.2 USB Connector (USB2)

Connector size	2 X 4 = 8 Pin			
Connector type	JST-2.0mm-M-180			
Connector location	USB2			
Connector pin definition	Pin	Signal	Pin	Signal
	1	5VSB	2	5VSB
	3	USB2 N	4	USB3 N
	5	USB2 P	6	USB3 P
	7	GND	8	GND

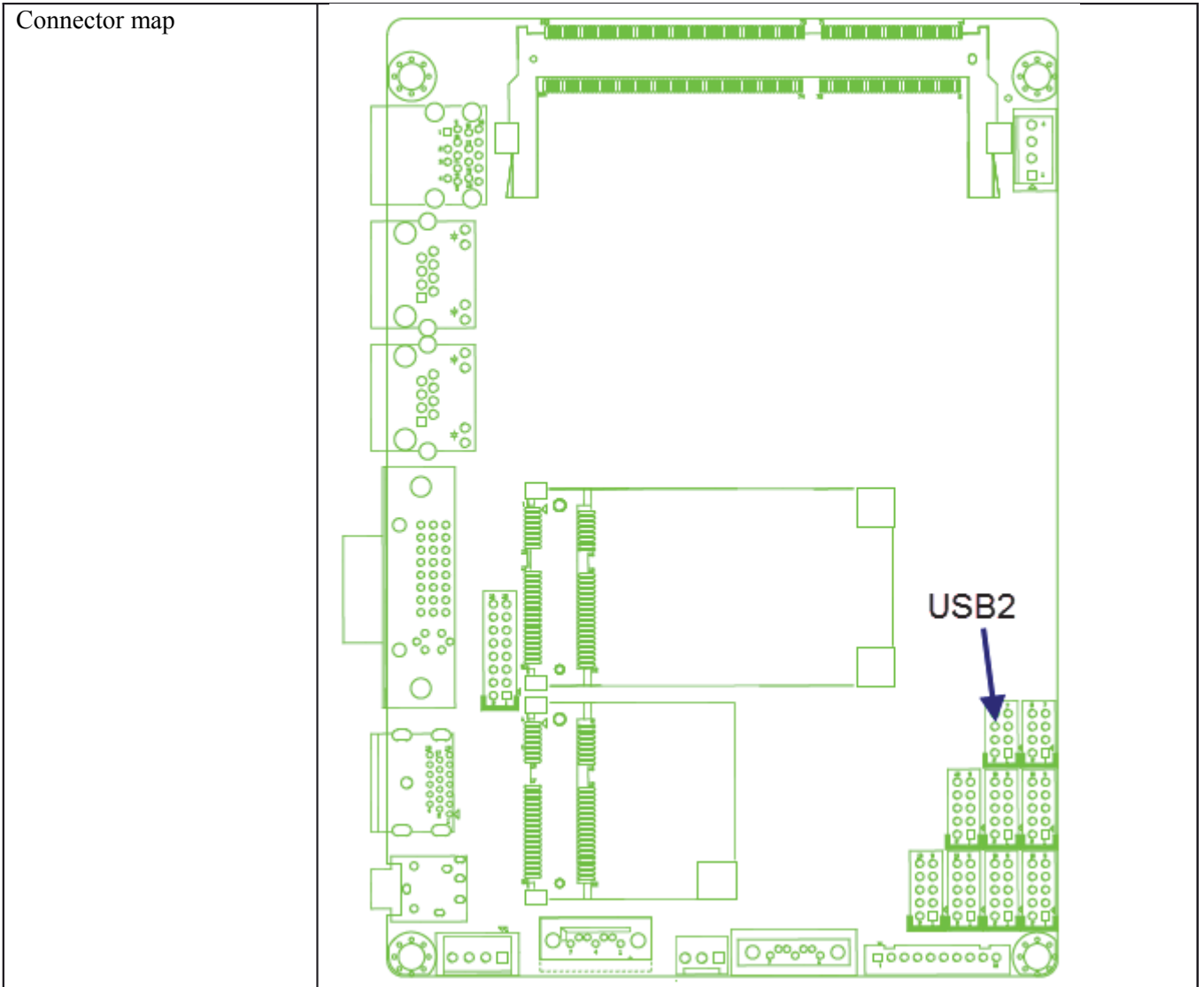

2.3 USB Connector (USB3)

Connector size	2 X 4 = 8 Pin			
Connector type	JST-2.0mm-M-180			
Connector location	USB3			
Connector pin definition	Pin	Signal	Pin	Signal
	1	5VSB	2	5VSB
	3	USB4 N	4	NC
	5	USB4 P	6	NC
	7	GND	8	GND

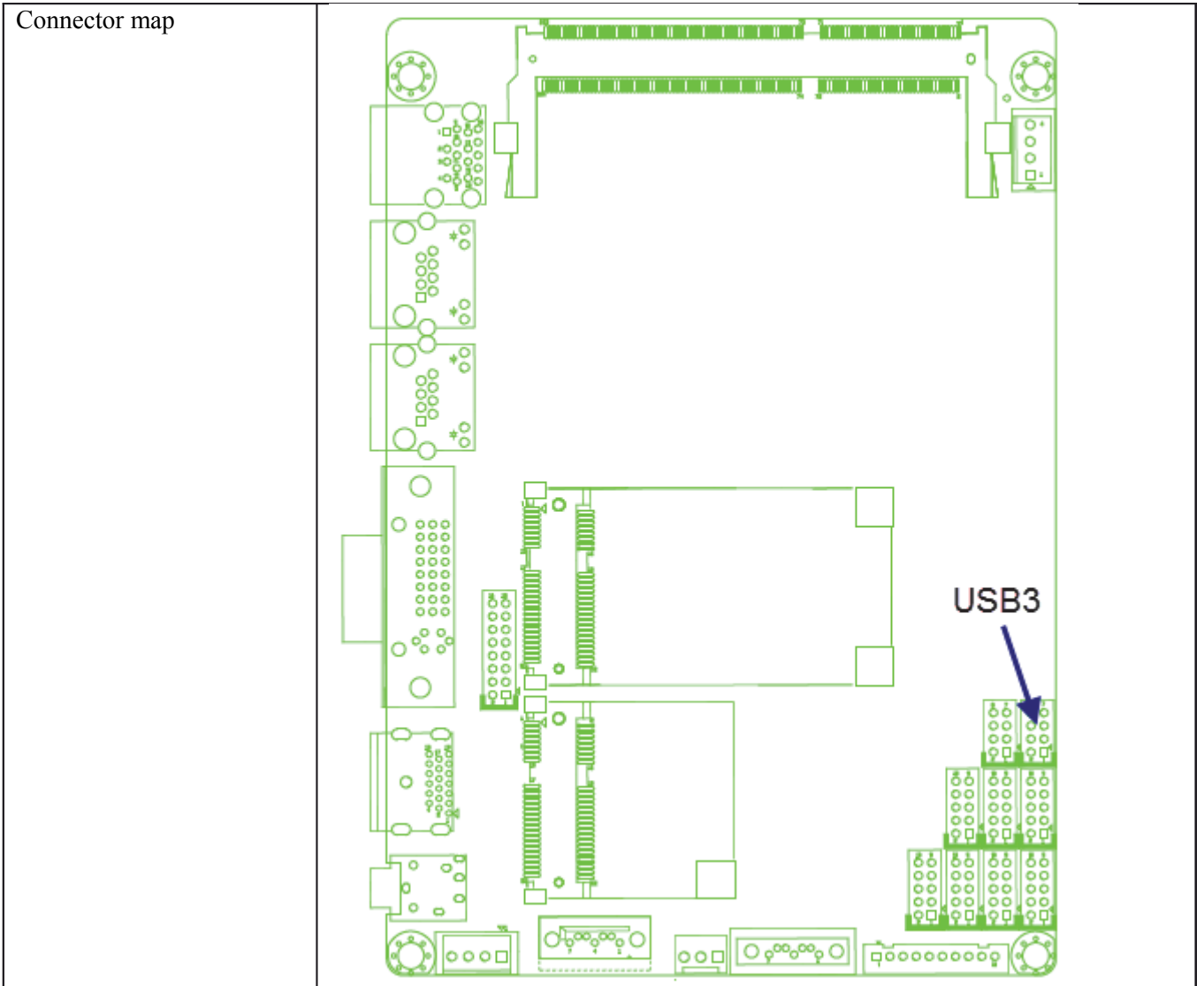

2.4 GPIO Connector

Connector size	2 X 5 = 10 Pin			
Connector type	JST-2.0mm-M-180			
Connector location	GPIO1			
Connector pin definition	Pin	Signal	Pin	Signal
	1	GND	2	+5V
	3	GPI0	4	GPO0
	5	GPI1	6	GPO1

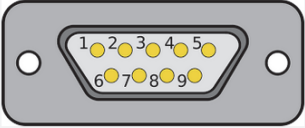
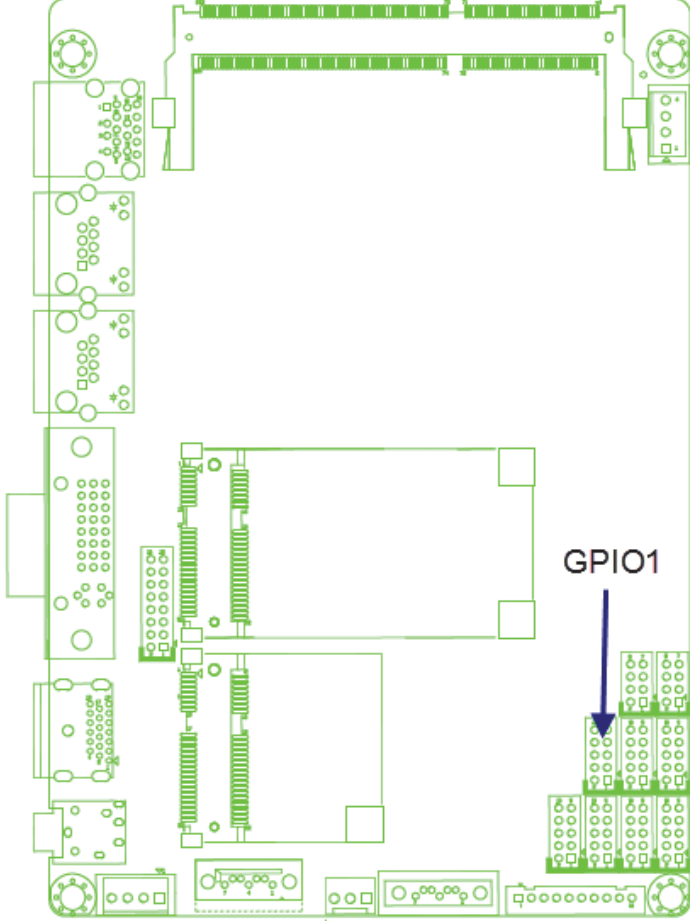
	7	GPI2	8	GPO2	
	9	GPI3	10	GPO3	
DB9 pin definition 	Pin	Signal			
		GPIO			
	1	GPI0			
	2	GPI1			
	3	GPI2			
	4	GPI3			
	5	GPO0			
	6	GPO1			
	7	GPO2			
	8	GPO3			
9	GND				
Connector map					

2.5 UART and GPIO Connector

Connector size	2 X 5 = 10 Pin			
Connector type	JST-2.0mm-M-180			
Connector location	UART1			
Connector pin definition	Pin	Signal	Pin	Signal

	1	GPIO0	2	GPIO6
	3	GPIO5	4	GPIO4
	5	GND	6	GPIO3
	7	GPIO1	8	GND
	9	GPIO2	10	+5V

Connector map	
---------------	--

2.6 LED Connector

Connector size	2 X 5 = 10 Pin			
Connector type	JST-2.0mm-M-180			
Connector location	LED1			
Connector pin definition	Pin	Signal	Pin	Signal

1	HDD LED N	2	HDD LED P
3	PWR LED N	4	PWR LED P
5	GND	6	PWRBT#
7	GND	8	HW RESET#
9	SMB CLK	10	SMB DATA

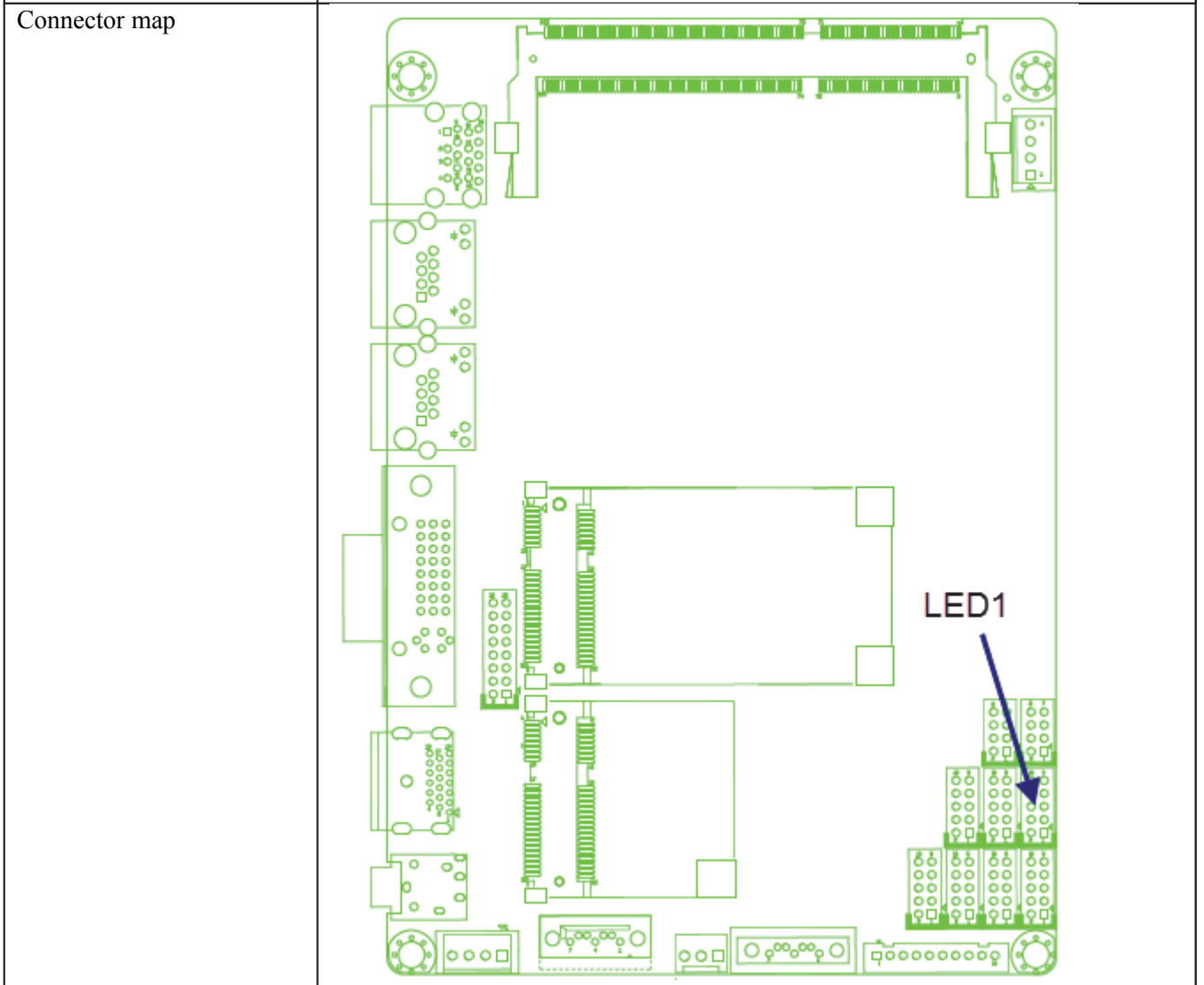

2.7 COM Connector (COM1)

Connector size	2 X 5 = 10 Pin			
Connector type	JST-2.0mm-M-180			
Connector location	COM1			
Connector pin definition	Pin	Signal	Pin	Signal

2.0 Internal Connector Specification

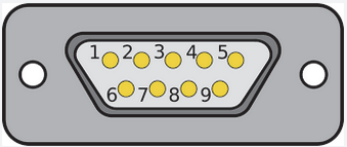
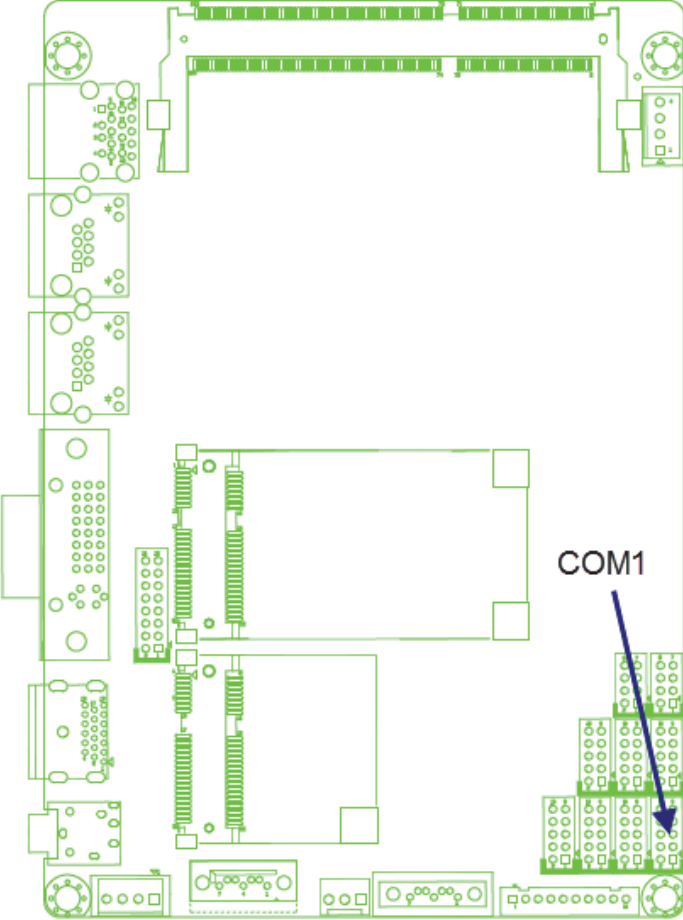
	<table border="1"> <tr> <td>1</td> <td>COM1 DCD</td> <td>2</td> <td>COM1 RXD</td> </tr> <tr> <td>3</td> <td>COM1 TXD</td> <td>4</td> <td>COM1 DTR</td> </tr> <tr> <td>5</td> <td>GND</td> <td>6</td> <td>COM1 DSR</td> </tr> <tr> <td>7</td> <td>COM1 RTS</td> <td>8</td> <td>COM1 CTS</td> </tr> <tr> <td>9</td> <td>COM1 RI</td> <td>10</td> <td>GND</td> </tr> </table>	1	COM1 DCD	2	COM1 RXD	3	COM1 TXD	4	COM1 DTR	5	GND	6	COM1 DSR	7	COM1 RTS	8	COM1 CTS	9	COM1 RI	10	GND																							
1	COM1 DCD	2	COM1 RXD																																									
3	COM1 TXD	4	COM1 DTR																																									
5	GND	6	COM1 DSR																																									
7	COM1 RTS	8	COM1 CTS																																									
9	COM1 RI	10	GND																																									
<p>DB9 pin definition</p> 	<table border="1"> <thead> <tr> <th rowspan="2">Pin</th> <th colspan="3">Signal</th> </tr> <tr> <th>RS232</th> <th>RS422</th> <th>RS485</th> </tr> </thead> <tbody> <tr> <td>1</td> <td>COM1 DCD</td> <td>TXD-</td> <td>TXD-/RXD-</td> </tr> <tr> <td>2</td> <td>COM1 RXD</td> <td>TXD+</td> <td>TXD+/RXD+</td> </tr> <tr> <td>3</td> <td>COM1 TXD</td> <td>RXD+</td> <td>NC</td> </tr> <tr> <td>4</td> <td>COM1 DTR</td> <td>RXD-</td> <td>NC</td> </tr> <tr> <td>5</td> <td>GND</td> <td>GND</td> <td>GND</td> </tr> <tr> <td>6</td> <td>COM1 DSR</td> <td>NC</td> <td>NC</td> </tr> <tr> <td>7</td> <td>COM1 RTS</td> <td>NC</td> <td>NC</td> </tr> <tr> <td>8</td> <td>COM1 CTS</td> <td>NC</td> <td>NC</td> </tr> <tr> <td>9</td> <td>COM1 RI</td> <td>NC</td> <td>NC</td> </tr> </tbody> </table>	Pin	Signal			RS232	RS422	RS485	1	COM1 DCD	TXD-	TXD-/RXD-	2	COM1 RXD	TXD+	TXD+/RXD+	3	COM1 TXD	RXD+	NC	4	COM1 DTR	RXD-	NC	5	GND	GND	GND	6	COM1 DSR	NC	NC	7	COM1 RTS	NC	NC	8	COM1 CTS	NC	NC	9	COM1 RI	NC	NC
Pin	Signal																																											
	RS232	RS422	RS485																																									
1	COM1 DCD	TXD-	TXD-/RXD-																																									
2	COM1 RXD	TXD+	TXD+/RXD+																																									
3	COM1 TXD	RXD+	NC																																									
4	COM1 DTR	RXD-	NC																																									
5	GND	GND	GND																																									
6	COM1 DSR	NC	NC																																									
7	COM1 RTS	NC	NC																																									
8	COM1 CTS	NC	NC																																									
9	COM1 RI	NC	NC																																									
<p>Connector map</p>																																												

2.8 COM Connector (COM2)

Connector size	2 X 5 = 10 Pin
----------------	----------------

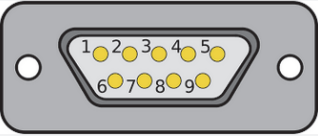
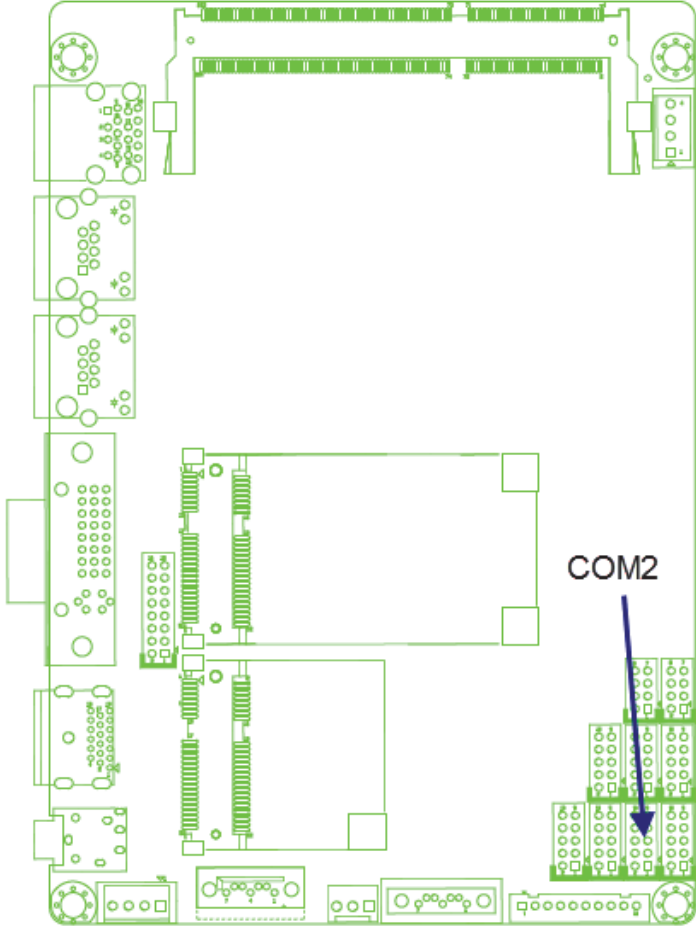
Connector type	JST-2.0mm-M-180			
Connector location	COM2			
Connector pin definition	Pin	Signal	Pin	Signal
	1	COM2_DCD	2	COM2_RXD
	3	COM2_TXD	4	COM2_DTR
	5	GND	6	COM2_DSR
	7	COM2_RTS	8	COM2_CTS
	9	COM2_RI	10	GND
DB9 pin definition	Pin	Signal		
		RS232	RS422	RS485
	1	COM2_DCD	TXD-	TXD-/RXD-
	2	COM2_RXD	TXD+	TXD+/RXD+
	3	COM2_TXD	RXD+	NC
	4	COM2_DTR	RXD-	NC
	5	GND	GND	GND
	6	COM2_DSR	NC	NC
	7	COM2_RTS	NC	NC
	8	COM2_CTS	NC	NC
	9	COM2_RI	NC	NC
Connector map				

2.9 COM Connector (COM3)

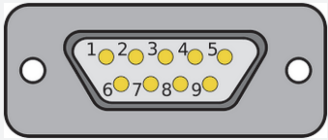
Connector size	2 X 5 = 10 Pin			
Connector type	JST-2.0mm-M-180			
Connector location	COM3			
Connector pin definition	Pin	Signal	Pin	Signal
	1	COM3_DCD	2	COM3_RXD
	3	COM3_TXD	4	COM3_DTR
	5	GND	6	COM3_DSR
	7	COM3_RTS	8	COM3_CTS
	9	COM3_RI	10	GND
DB9 pin definition 	Pin	Signal		
		RS232		
	1	COM3_DCD		
	2	COM3_RXD		
	3	COM3_TXD		
	4	COM3_DTR		
	5	GND		
	6	COM3_DSR		
	7	COM3_RTS		
	8	COM3_CTS		
9	COM3_RI			

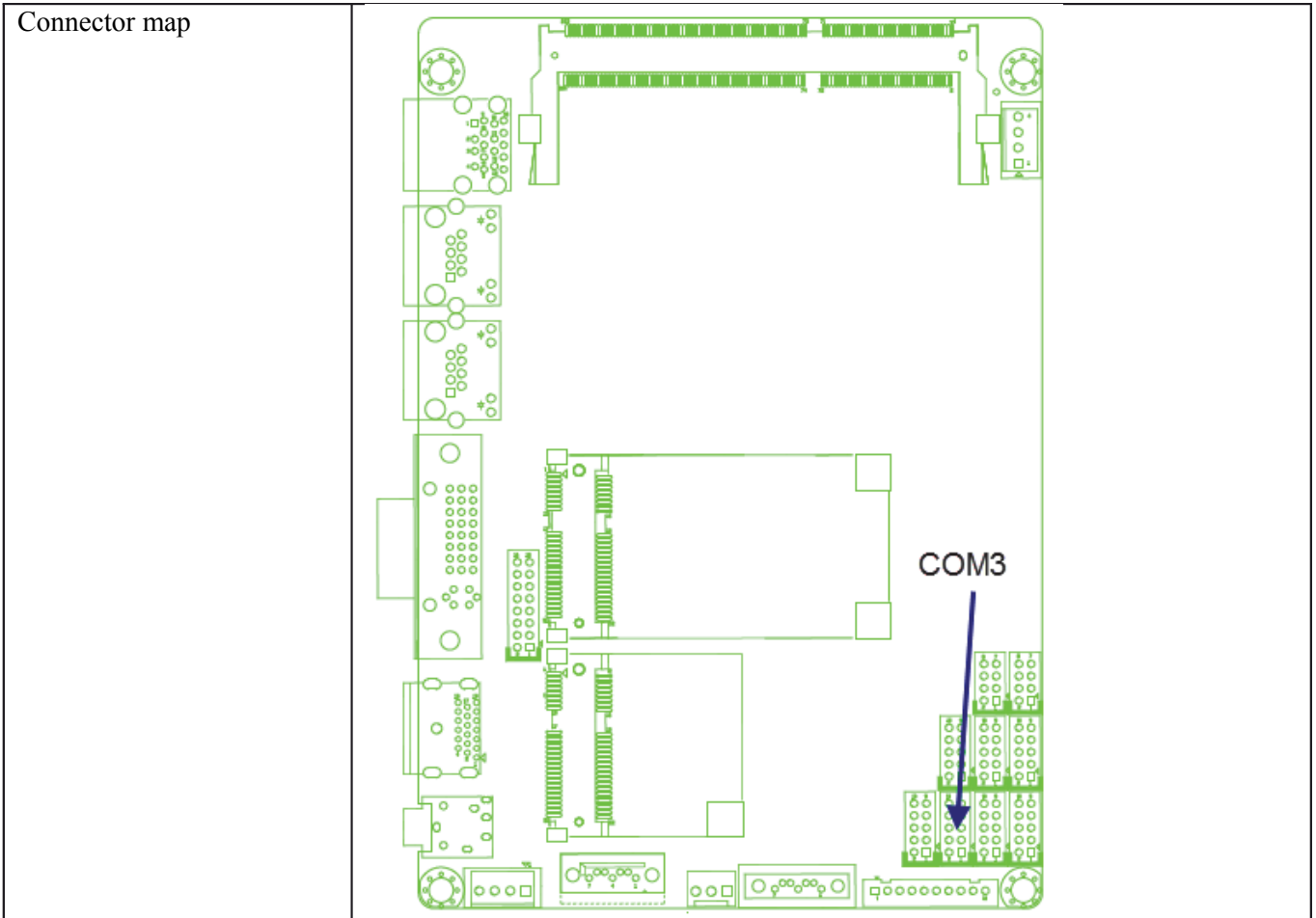

2.10 COM Connector (COM4)

Connector size	2 X 5 = 10 Pin			
Connector type	JST-2.0mm-M-180			
Connector location	COM3			
Connector pin definition	Pin	Signal	Pin	Signal
	1	COM4 DCD	2	COM4 RXD
	3	COM4 TXD	4	COM4 DTR
	5	GND	6	COM4 DSR
	7	COM4 RTS	8	COM4 CTS
	9	COM4 RI	10	GND
DB9 pin definition	Pin	Signal		
		RS232		
	1	COM4 DCD		
	2	COM4 RXD		
	3	COM4 TXD		
	4	COM4 DTR		
	5	GND		
	6	COM4 DSR		
7	COM4 RTS			

	8	COM4 CTS		
	9	COM4 RI		
Connector map				

2.11 AUDIO Connector

Connector size	1 X 10 = 10 Pin		
Connector type	JST-2.0mm-M-180		
Connector location	AUDIO1		
Connector pin definition	Pin	Signal	
	1	CEN OUT L	
	2	CEN OUT L	
	3	CEN-JD	
	4	LINE IN L	
	5	LINE IN R	
	6	LINE-JD	
	7	MIC IN L	
	8	MIC IN R	
	9	MIC-JD	
	10	GND	

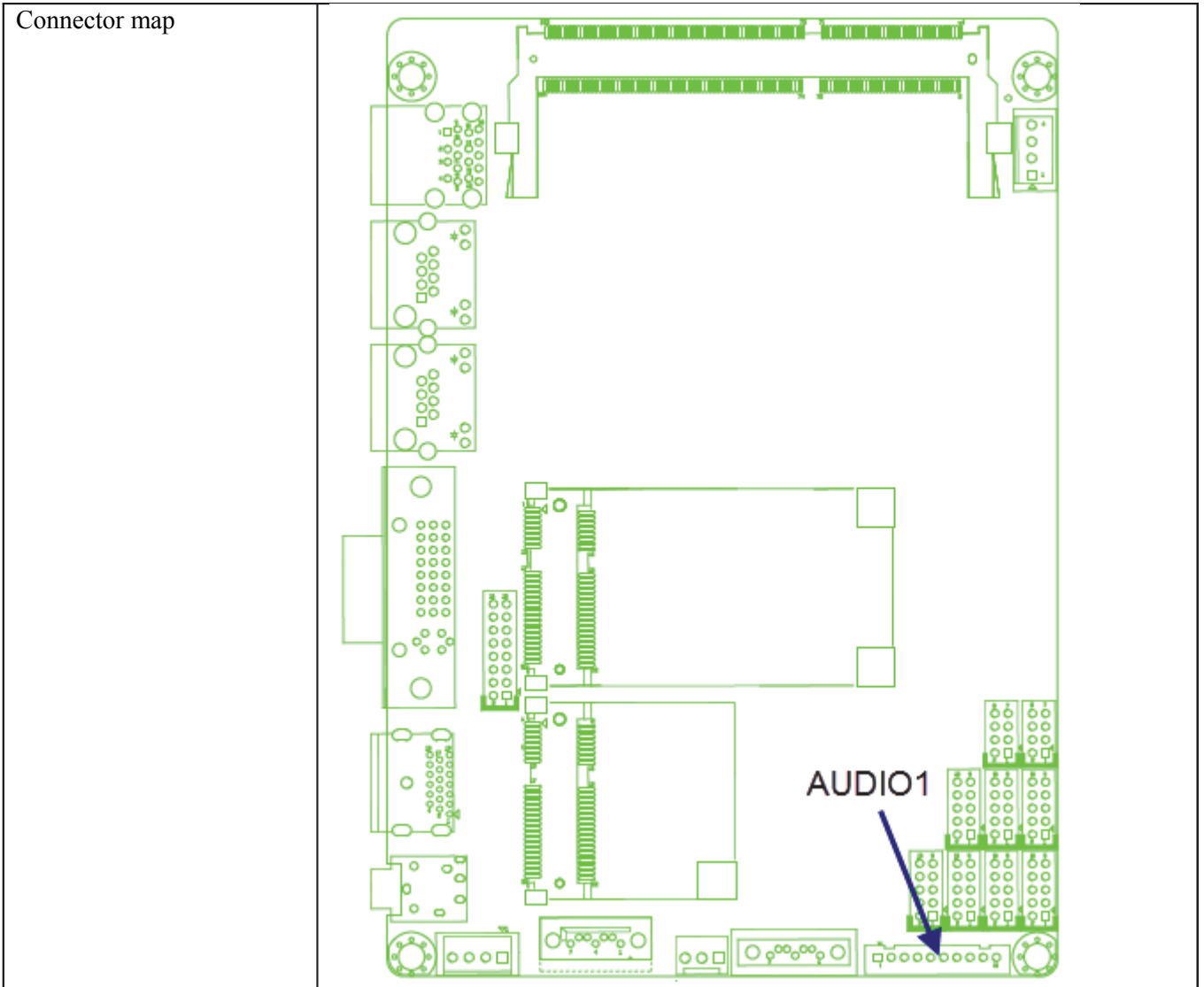

2.12 SATA Connector (SATA1)

Connector size	1 X 7 = 7 Pin	
Connector type	SATA 1.27mm-M-180D	
Connector location	SATA1	
Connector pin definition	Pin	Signal
	1	GND
	2	SATA TXP0
	3	SATA TXN0
	4	GND
	5	SATA RXN0
	6	SATA RXP0
	7	GND

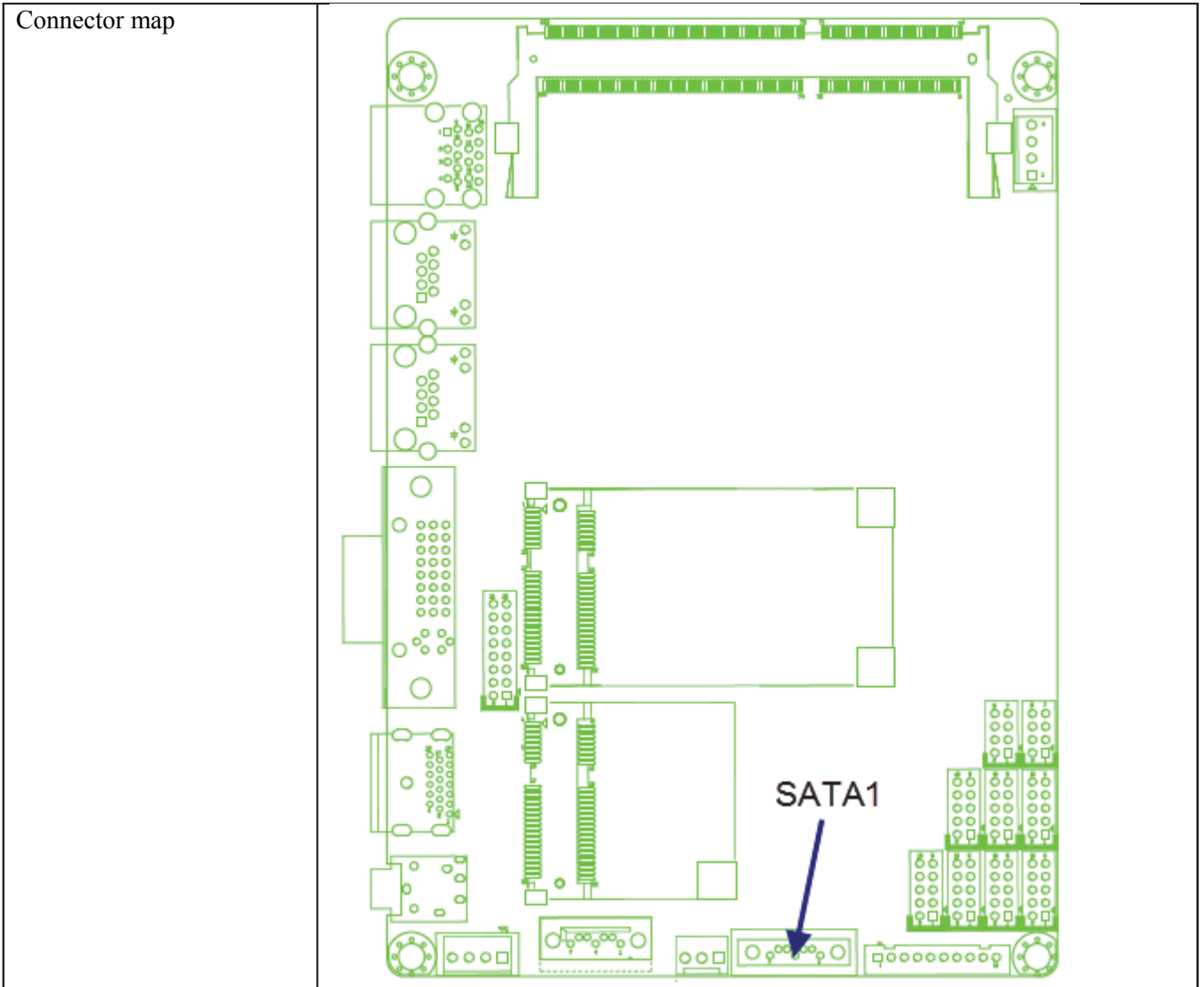

2.13 SATA Connector (SATA2)

Connector size	1 X 7 = 7 Pin	
Connector type	SATA 1.27mm-M-180D	
Connector location	SATA2	
Connector pin definition	Pin	Signal
	1	GND
	2	SATA TXP1
	3	SATA TXN1
	4	GND
	5	SATA RXN1
	6	SATA RXP1
	7	GND

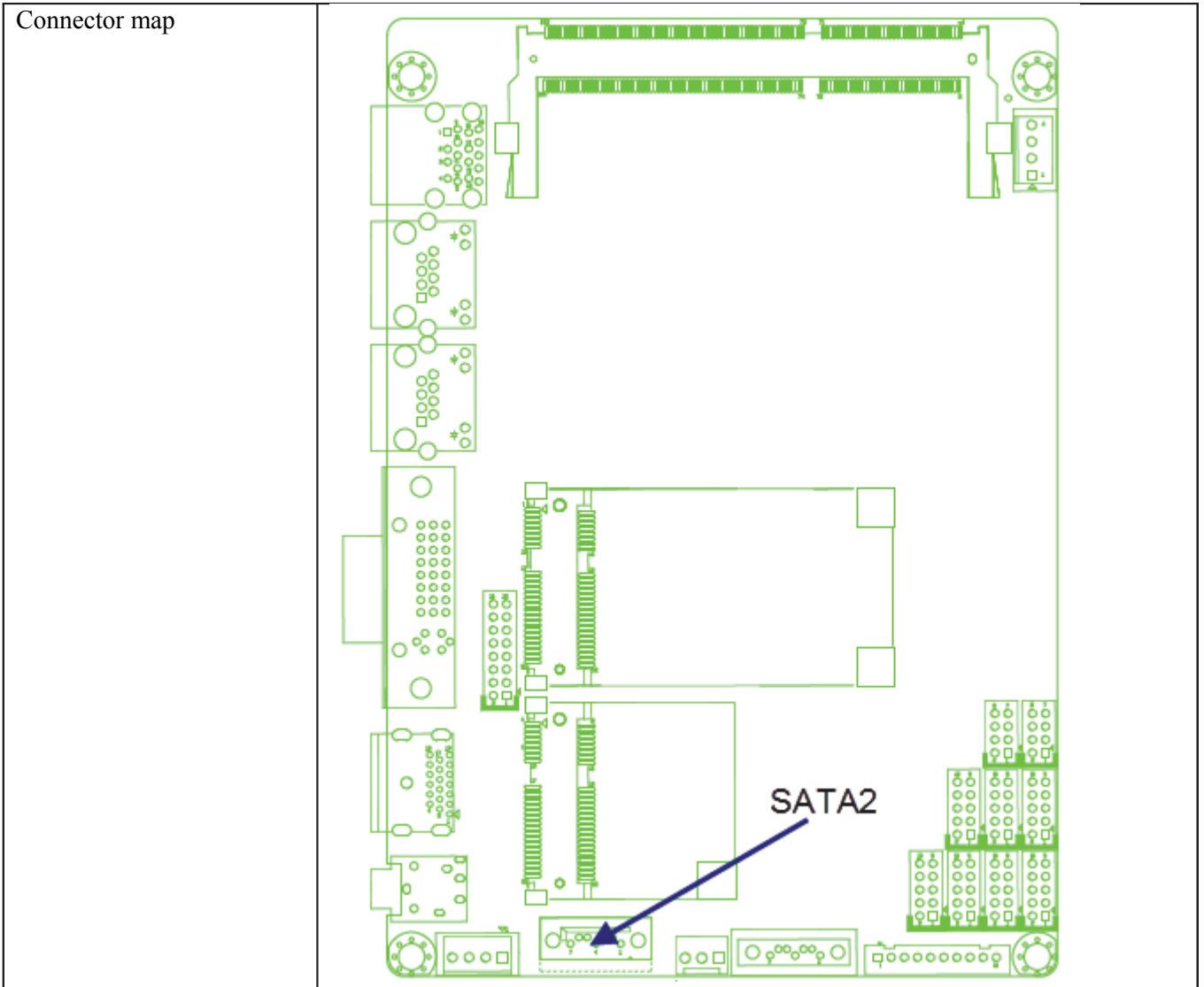

2.14 Mini PCI-E Connector (MINICARD1)

Connector size	2 X 26 = 52 Pin			
Connector type	MINI PCI-E CON 9.2mmH			
Connector location	MINICARD1			
Connector pin definition	Pin	Signal	Pin	Signal
	1	PCIE_WAKE#	2	3VSB
	3	NC	4	GND
	5	NC	6	+1.5V
	7	MINICARD0_CLKREQ#	8	NC
	9	GND	10	NC
	11	PCIE_MCARD0_CLK_N	12	NC
	13	PCIE_MCARD0_CLK_P	14	NC

2.0 Internal Connector Specification

	15	GND	16	NC
	17	NC	18	GND
	19	NC	20	MINICARD0 DIS#
	21	GND	22	PCIE_RST#
	23	PCIE_MCARD0_RX_N	24	3VSB
	25	PCIE_MCARD0_RX_P	26	GND
	27	GND	28	+1.5V
	29	GND	30	SMB_CLK
	31	PCIE_MCARD0_TX_N	32	SMB_DATA
	33	PCIE_MCARD0_TX_P	34	GND
	35	GND	36	USB_6N
	37	GND	38	USB_6P
	39	3VSB	40	GND
	41	3VSB	42	NC
	43	GND	44	NC
	45	NC	46	NC
	47	NC	48	+1.5V
	49	NC	50	GND
	51	NC	52	3VSB

Connector map

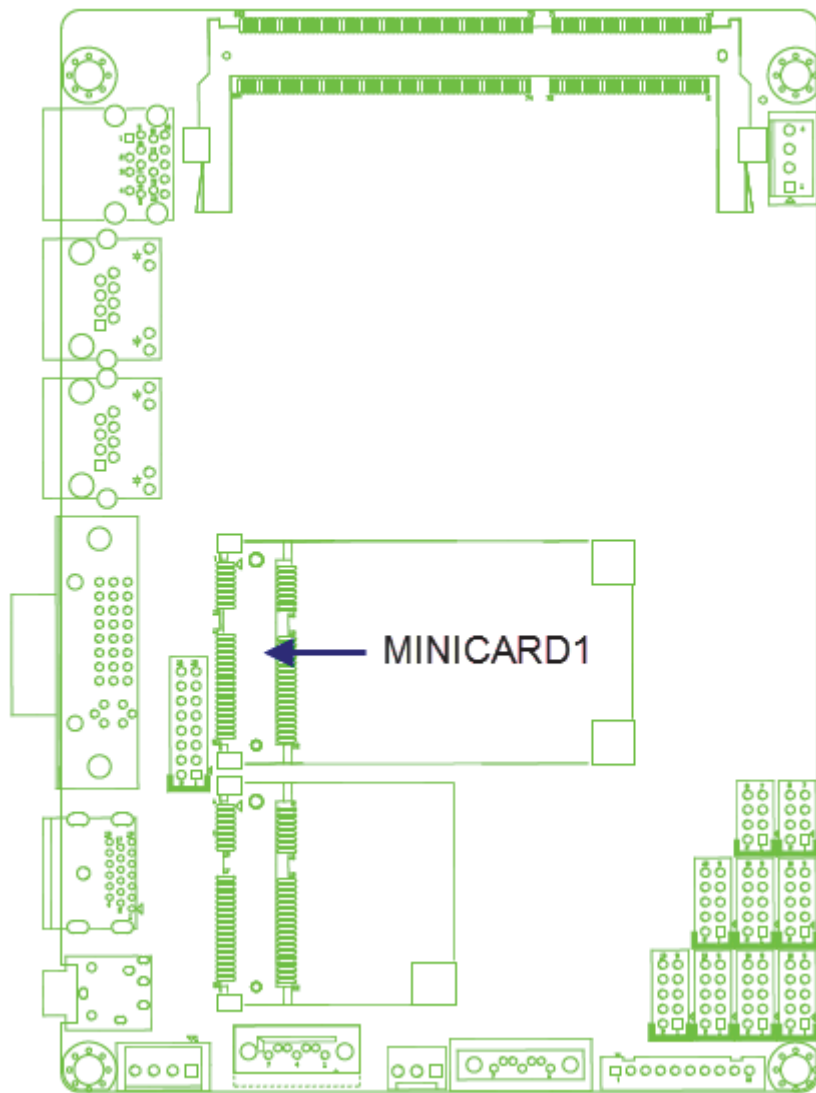

2.15 Mini PCI-E Connector (MINICARD2)

Connector size	2 X 26 = 52 Pin			
Connector type	MINI PCI-E CON 9.2mmH			
Connector location	MINICARD2			
Connector pin definition	Pin	Signal	Pin	Signal
	1	PCIE_WAKE#	2	3VSB
	3	NC	4	GND
	5	NC	6	+1.5V
	7	MINICARD1_CLKREQ#	8	NC
	9	GND	10	NC
	11	PCIE_MCARD1_CLK_N	12	NC
	13	PCIE_MCARD1_CLK_P	14	NC
	15	GND	16	NC
	17	NC	18	GND
	19	NC	20	MINICARD1_DIS#
	21	GND	22	PCIE_RST#
	23	PCIE_MCARD1_RX_N	24	3VSB
	25	PCIE_MCARD1_RX_P	26	GND
	27	GND	28	+1.5V
	29	GND	30	SMB_CLK
	31	PCIE_MCARD1_TX_N	32	SMB_DATA
	33	PCIE_MCARD1_TX_P	34	GND
	35	GND	36	USB_5N
	37	GND	38	USB_5P
	39	3VSB	40	GND
	41	3VSB	42	NC
	43	GND	44	NC
	45	NC	46	NC
	47	NC	48	+1.5V
	49	NC	50	GND
51	NC	52	3VSB	

Connector map

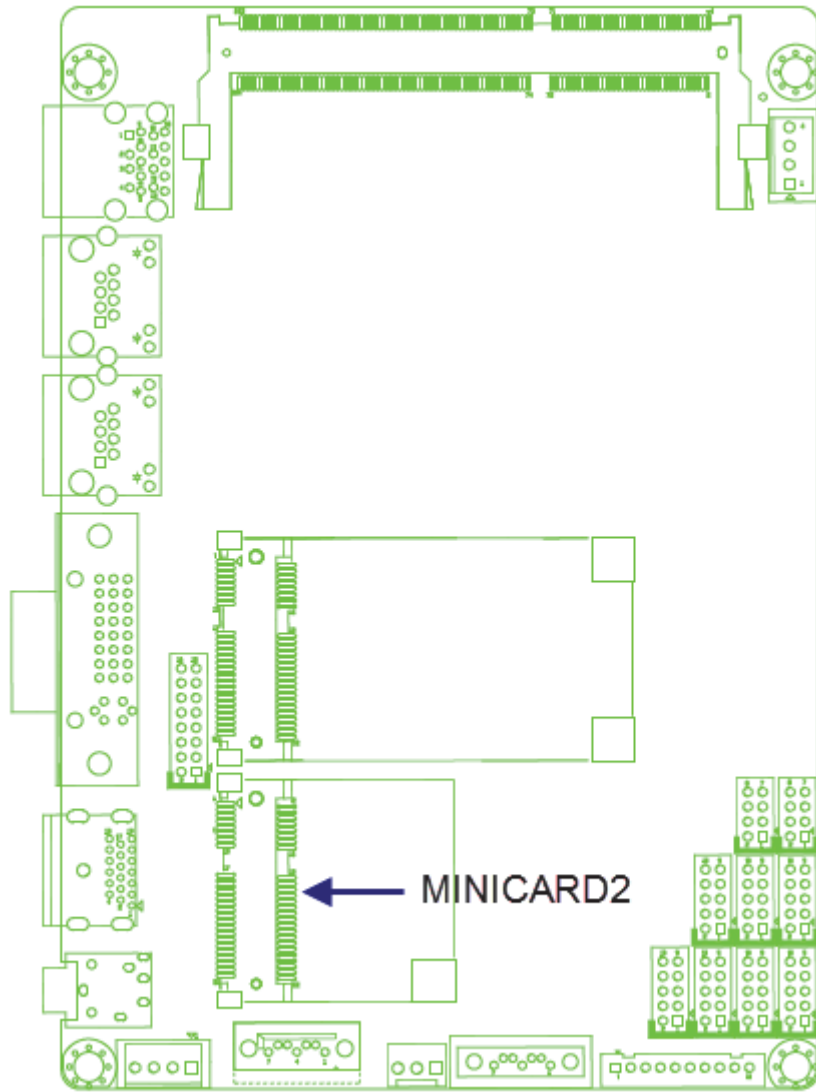

2.16 Power Input Connector

Connector size	1 X 4 = 4 Pin	
Connector type	WAFER 2.54mm-M-180	
Connector location	PWRIN1	
Connector pin definition	Pin	Signal
	1	+12VSB
	2	+12VSB
	3	GND
	4	GND

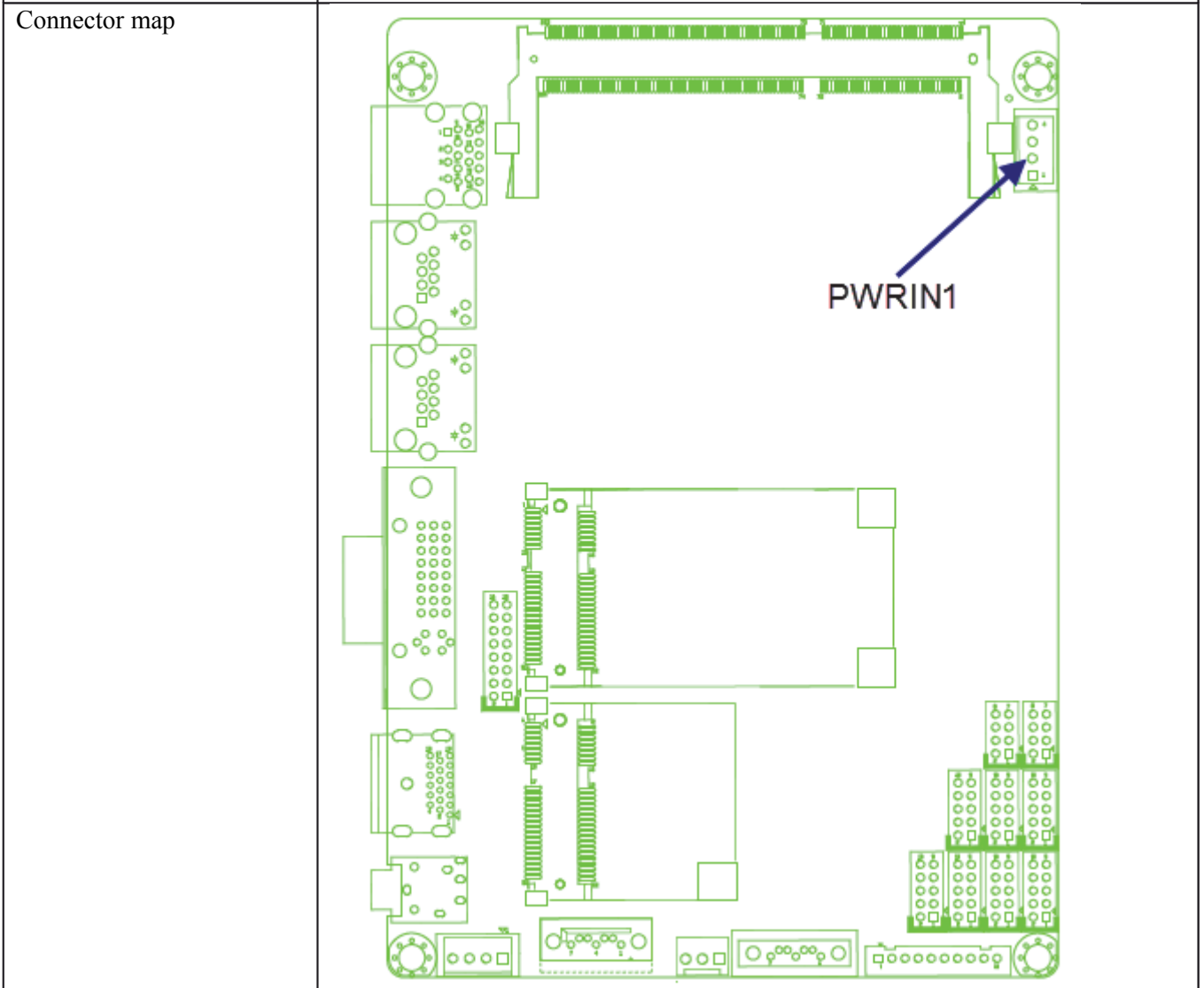

2.17 SATA Power Connector (SPWR1)

Connector size	1 X 4 = 4 Pin	
Connector type	WAFER 2.54mm-M-180	
Connector location	SPWR1	
Connector pin definition	Pin	Signal
	1	+5V
	2	GND
	3	GND
	4	+12V
Connector map		

2.18 SATA Power Connector (SPWR2)

Connector size	1 X 3 = 3 Pin	
Connector type	WAFER 2.54mm-M-180	
Connector location	SPWR2	
Connector pin definition	Pin	Signal
	1	+12V
	2	+5V
	3	GND
Connector map		

3.0 EXTERNAL CONNECTOR SPECIFICATION

3.0 EXTERNAL CONNECTOR SPECIFICATION

3.1 USB Connector

Connector size	18 Pin			
Connector type	Type A			
Connector location	USB1			
Connector pin definition	Pin	Signal	Pin	Signal
	1	5VSB	2	USB0_N
	3	USB0_P	4	GND
	5	SSRX0_N	6	SSRX0_P
	7	GND	8	SSTX0_N
	9	SSTX0_P	10	5VSB
	11	USB1_N	12	USB1_P
	13	GND	14	SSRX1_N
	15	SSRX1_P	16	GND
	17	SSTX1_N	18	SSTX1_P

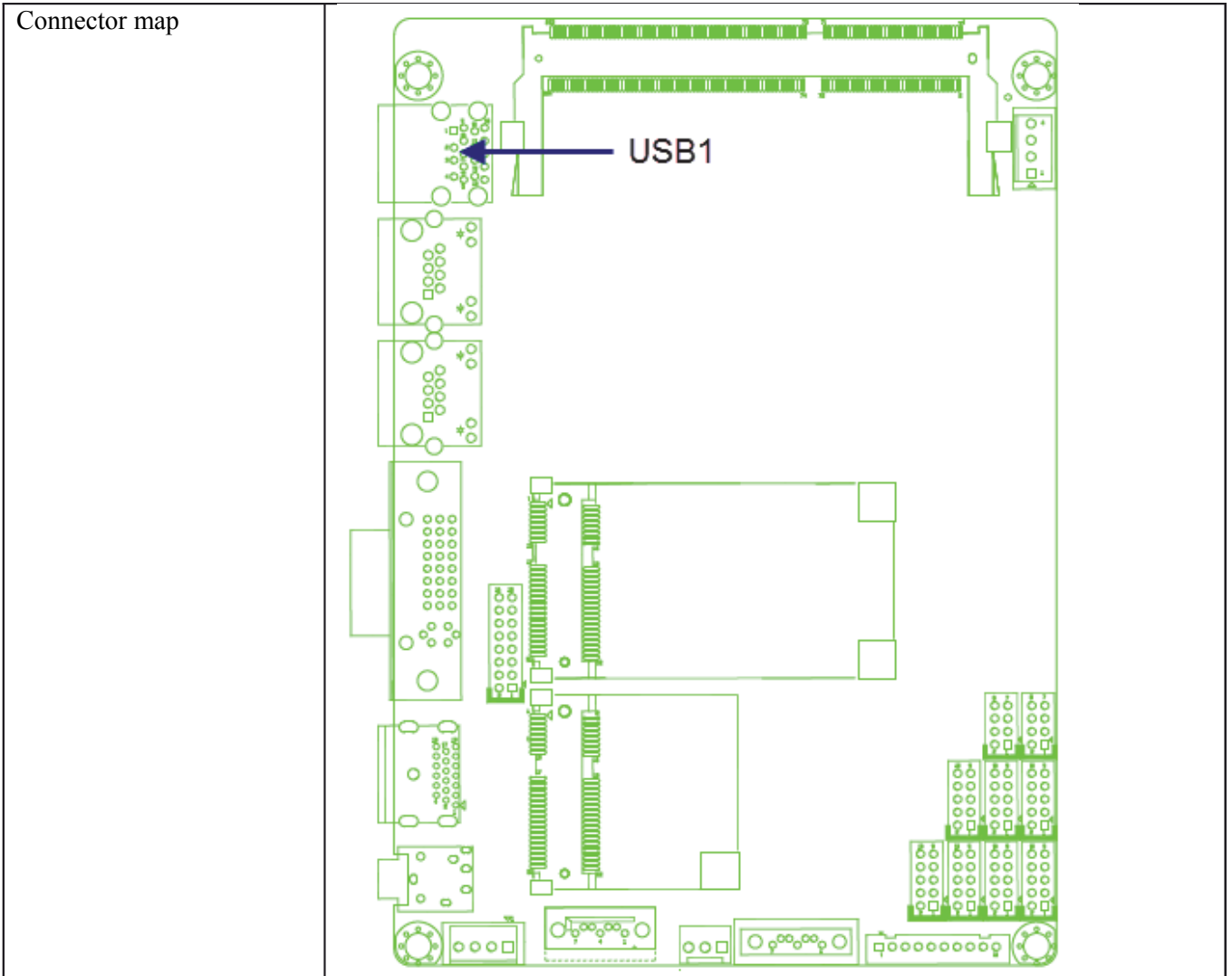

3.2 LAN Connector (LAN1)

5.2 LAN connector				
Connector size	12 Pin			
Connector type	RJ45+LED			
Connector location	LAN1			
Connector pin definition	Pin	Signal	Pin	Signal
	1	LAN0 MDI0P	2	LAN0 MDI0N
	3	LAN0 MDI1P	4	LAN0 MDI2P
	5	LAN0 MDI2N	6	LAN0 MDI1N
	7	LAN0 MDI3P	8	LAN0 MDI3N
	9	LAN0 ACT#	10	LAN0 ACTPW
	11	LAN0 LINK#	12	LAN0 LINKPW

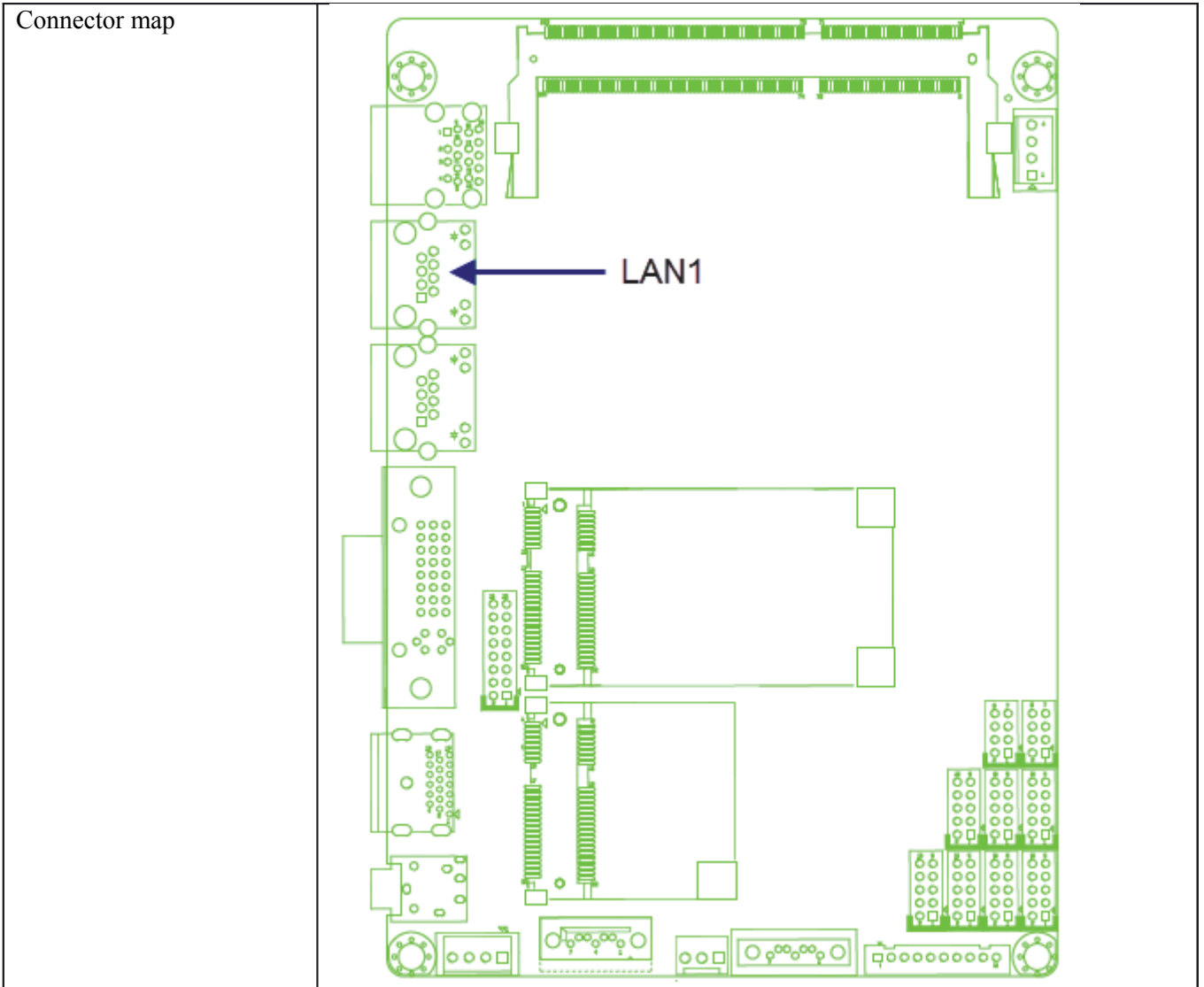

3.3 LAN Connector (LAN2)

Connector size	12 Pin			
Connector type	RJ45+LED			
Connector location	LAN2			
Connector pin definition	Pin	Signal	Pin	Signal
	1	LAN1 MDI0P	2	LAN1 MDI0N
	3	LAN1 MDI1P	4	LAN1 MDI2P
	5	LAN1 MDI2N	6	LAN1 MDI1N
	7	LAN1 MDI3P	8	LAN1 MDI3N
	9	LAN1 ACT#	10	LAN1 ACTPW
	11	LAN1 LINK#	12	LAN1 LINKPW

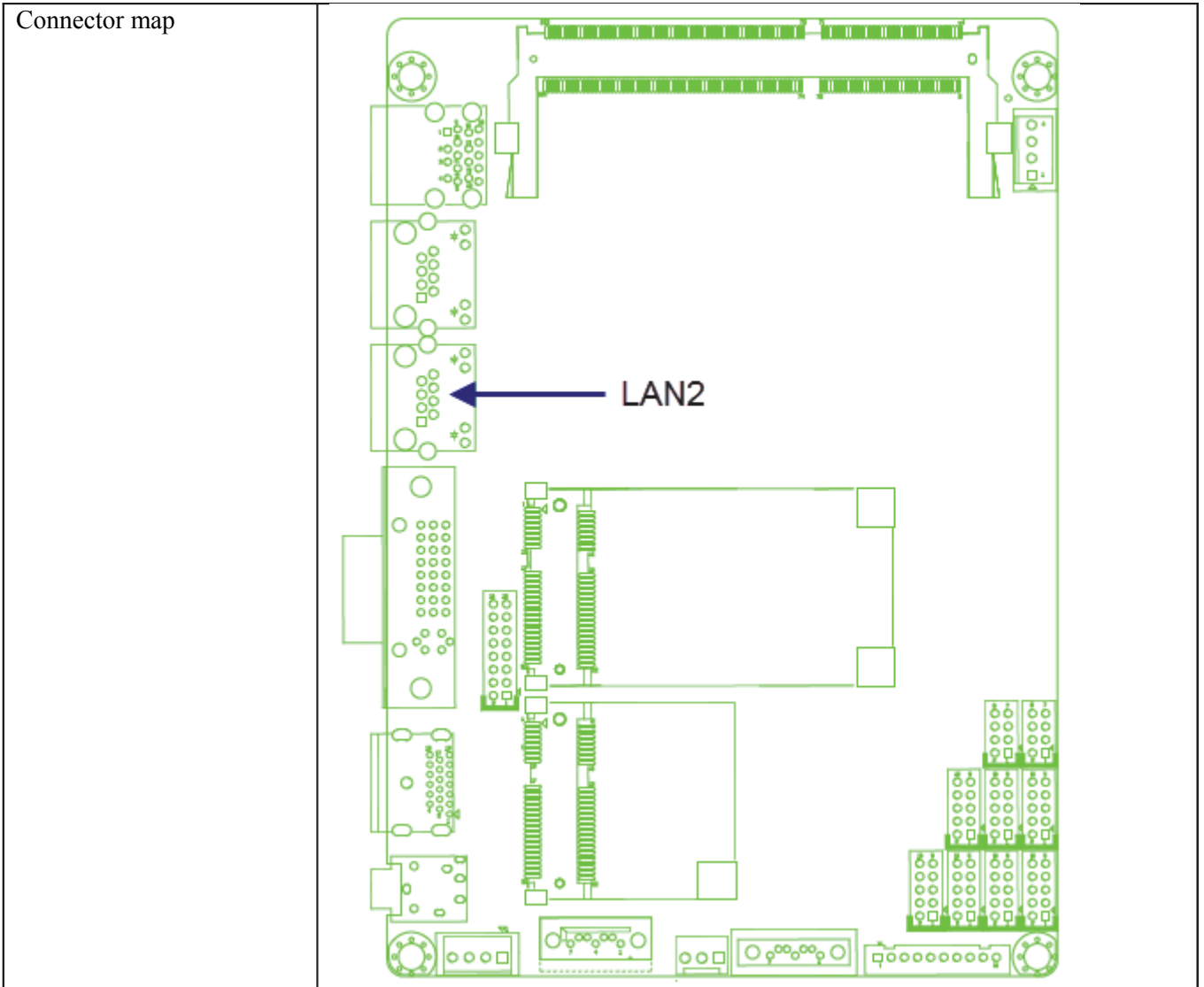

3.4 DVI-I Connector

Connector size	30 Pin			
Connector type	DVI-I			
Connector location	DVI-I1			
Connector pin definition	Pin	Signal	Pin	Signal
	1	DVI TX2 N	2	DVI TX2 P
	3	GND	4	5VSB
	5	+12V	6	DVI DDC_CLK
	7	DVI DDC_DATA	8	CRT VSYNC
	9	DVI TX1 N	10	DVI TX1 P
	11	GND	12	USB 7N
	13	USB 7P	14	+5V DVI_PWR

	15	GND	16	DVI HPD
	17	DVI TX0 N	18	DVI TX0 P
	19	GND	20	CRT DAC SDA
	21	CRT DAC SCL	22	NC
	23	DVI CLK P	24	DVI CLK N
	C1	CRT RED	C2	CRT GREEN
	C3	CRT BLUE	C4	CRT HSYNC
	C5	CRT DET	C6	GND

Connector map

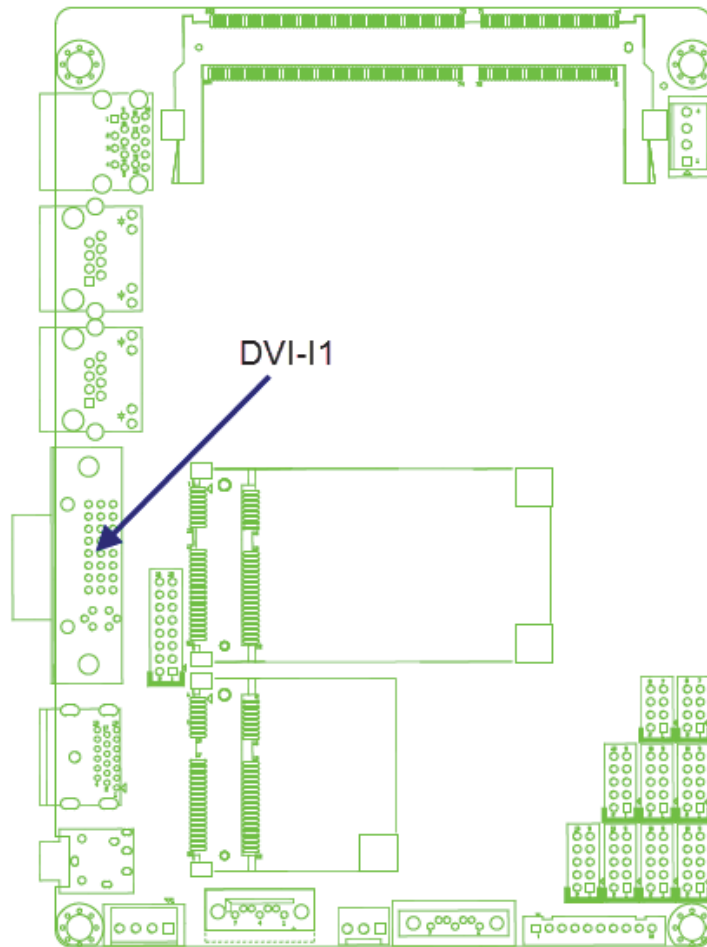

3.5 HDMI Connector

Connector size	19 Pin			
Connector type	HDMI			
Connector location	HDMI1			
Connector pin definition	Pin	Signal	Pin	Signal
	1	HDMI DATA2 P	2	GND
	3	HDMI DATA2 N	4	HDMI DATA1 P
	5	GND	6	HDMI DATA1 N
	7	HDMI DATA0 P	8	GND
	9	HDMI DATA0 N	10	HDMI CLK P

	11	GND	12	HDMI CLK N
	13	NC	14	NC
	15	HDMI SCL	16	HDMI DATA
	17	GND	18	+5V
	19	HDMI HPD		
Connector map				

3.6 Audio Connector

Connector size	6Pin			
Connector type	PHONE JACK			
Connector location	LOUT1			
Connector pin definition	Pin	Signal	Pin	Signal
	1	FRONT OUT R	2	FRONT-JD
	3	NC	4	FRONT OUT L
	5	GND	6	GND

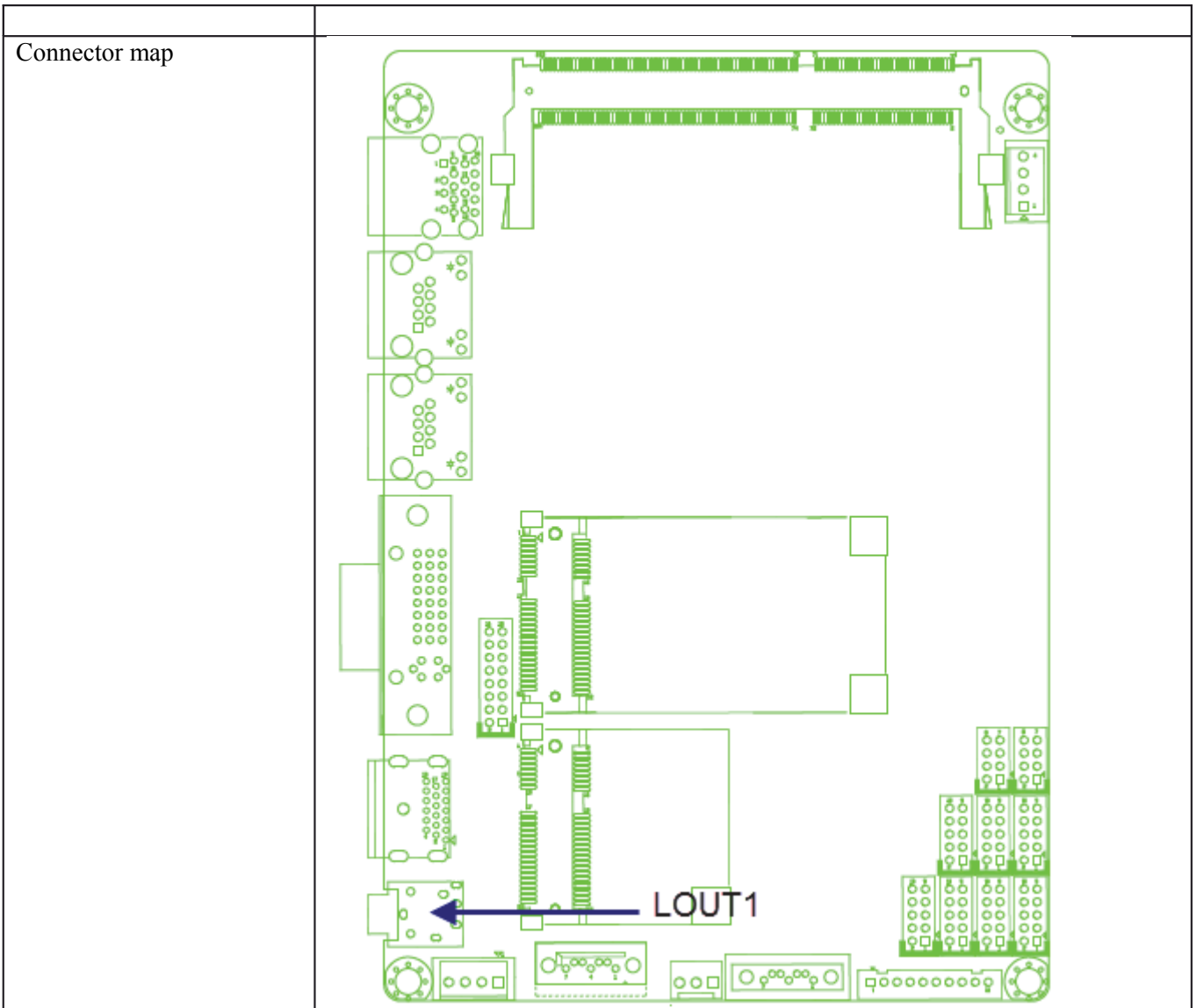

3.6 Power Input Connector

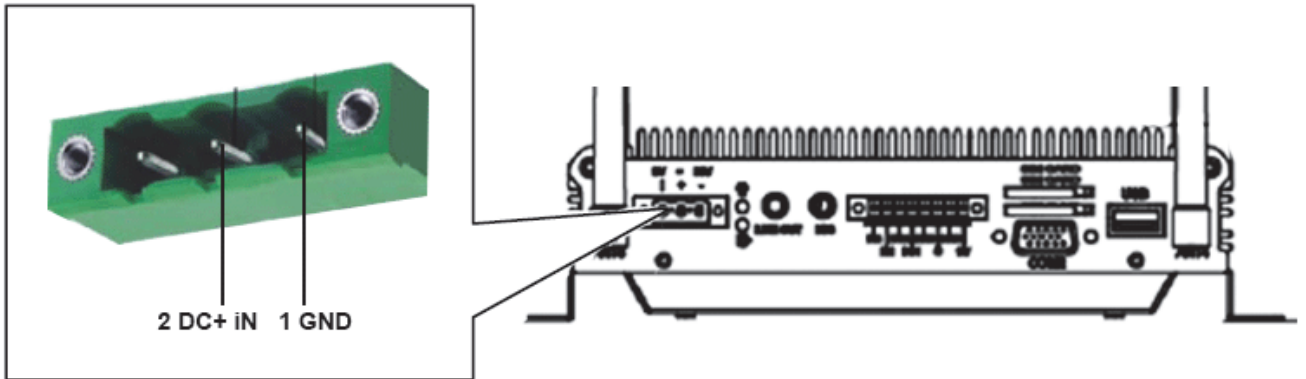

FleetPC-4-C's Power Wiring Diagram

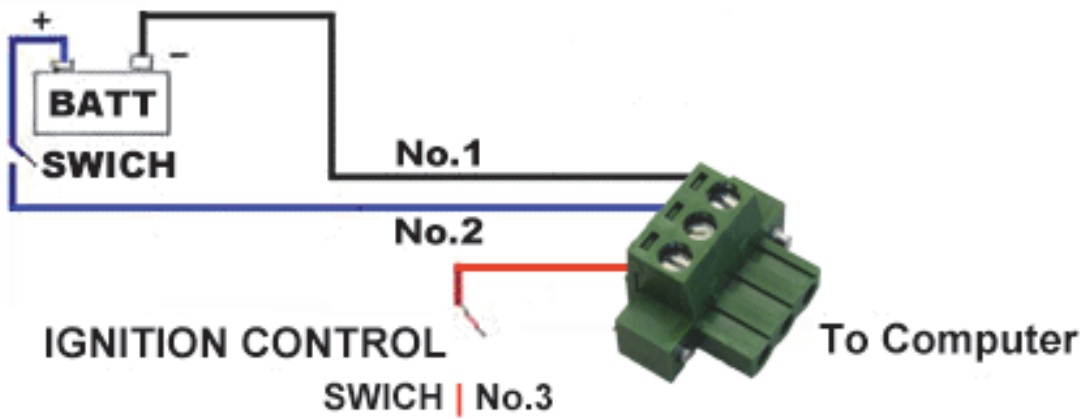

Computer connector :

- pin1-Ground
- pin2-DC+ 9~36V
- pin3-Ignition

3.7 DIO Connector

DI Dry Contact Wiring

Power Button Wiring

DI Source :
 Input Low = <3.0V
 Input High= >3.3V
 Max. Input = <32V

DO
 High : 12V / 80mA
 Low : 0V

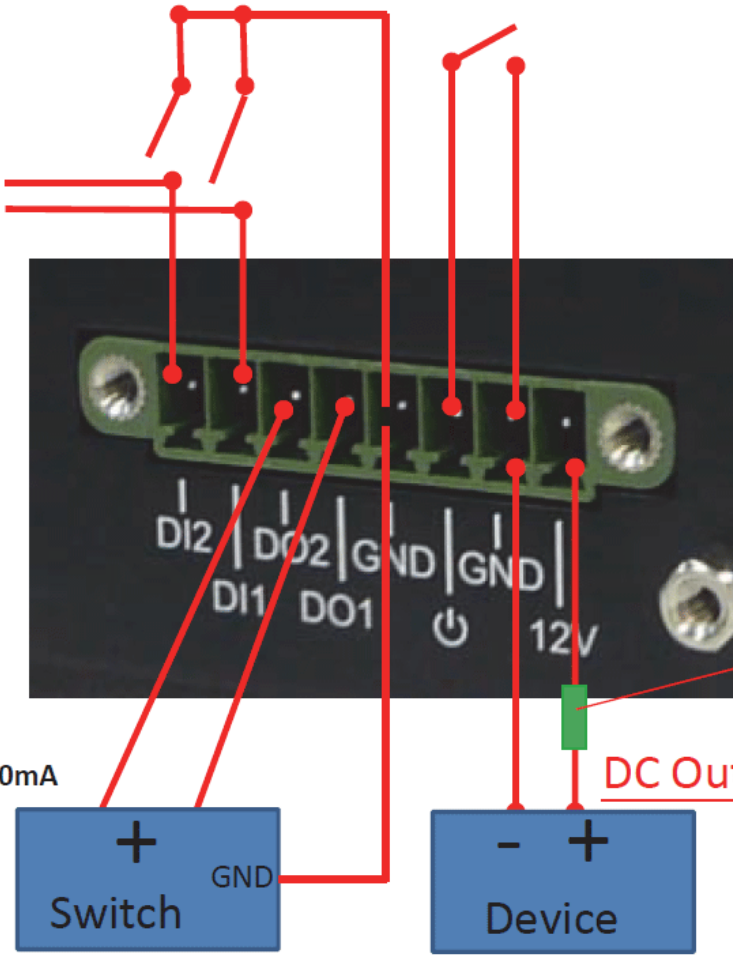

External Fuse 2A required

DC Output 12V / 2A

4.0 SYSTEM INSTALLATION

4.0 SYSTEM INSTALLATION

4.1 System Introduction

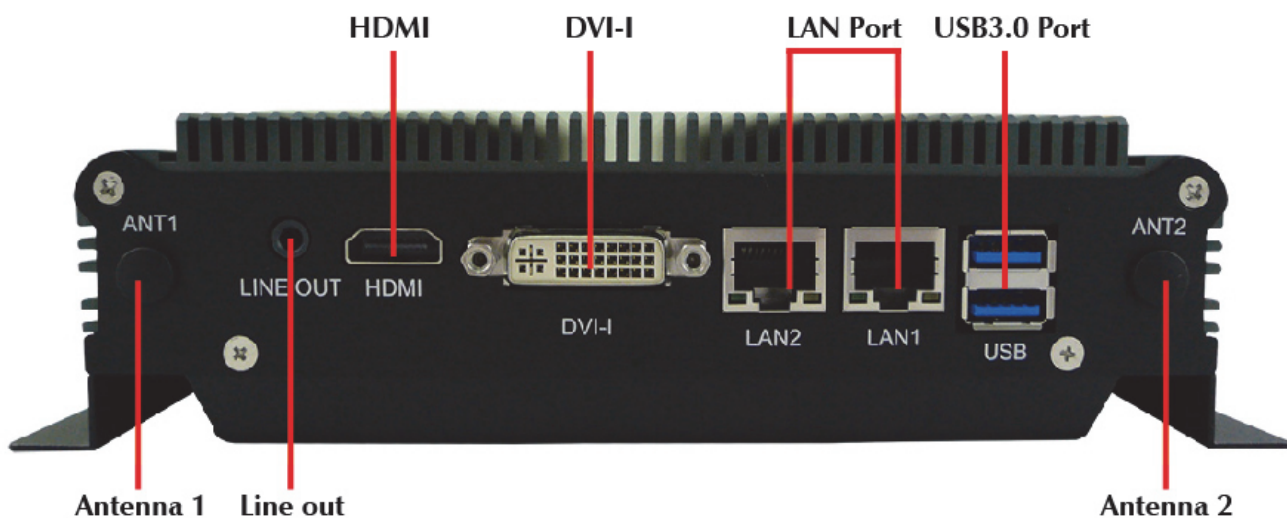
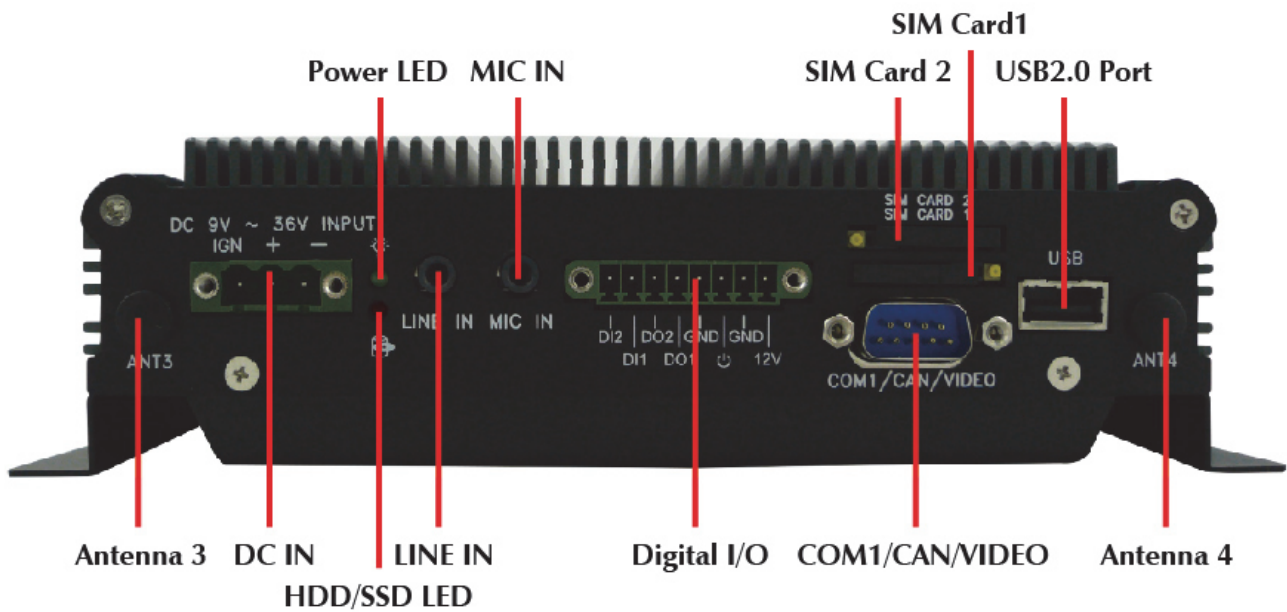

4.2 Opening Chassis

Step1. Unscrew the four screws of the Back Cover as shown in the picture.

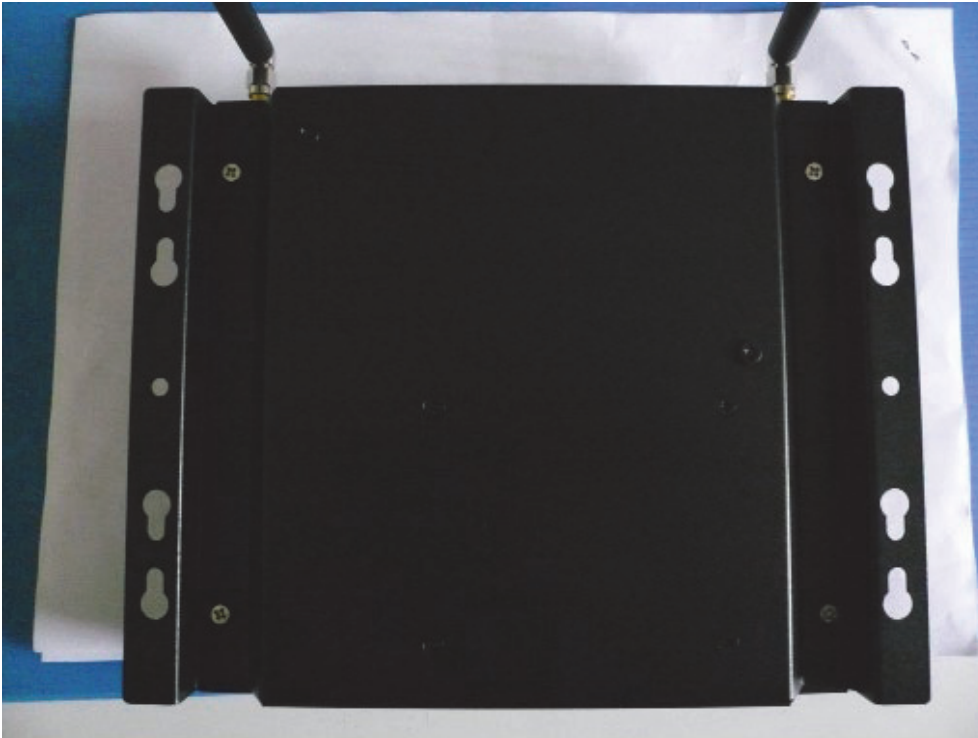

Step2. Unscrew the four screws of Rear/Front Panel as shown in the picture.



Step3. Open the Back Cover as shown in the picture.



4.3 Installing Memory

Step 1. Put Memory on this place as shown in the picture.



Step 2. Hold the Memory with its notch aligned with the Memory socket of the board and insert it at a 30-degree angle into the socket as shown in the picture.



Step 3. Fully insert the module into the socket until a “click” is heard as shown in the picture.



Step 4. Press down on the Memory so that the tabs of the socket lock on both sides of the module.



Step 3. Connect the HDD power cable and SATA cable to HDD as shown in the picture.



4.5 Installing MINI PCIe Expansion Card

Step 1. Put MINI PCIe Expansion Card on this place as shown in the picture.

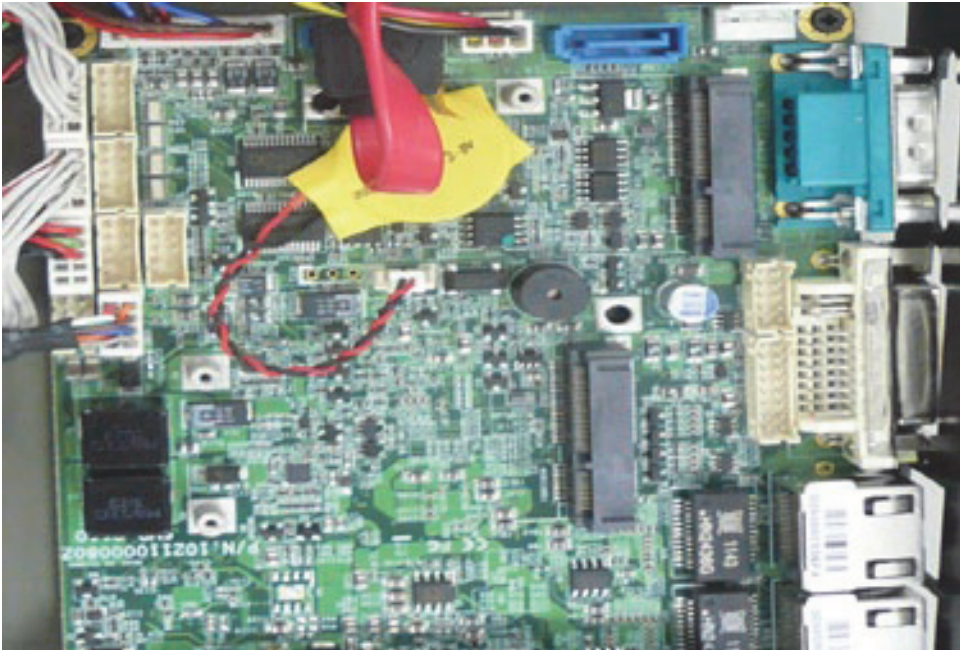

Step 2. Hold the Module with its notch aligned with the socket of the board and insert it at a 30 degree angle into the socket as shown in the picture.

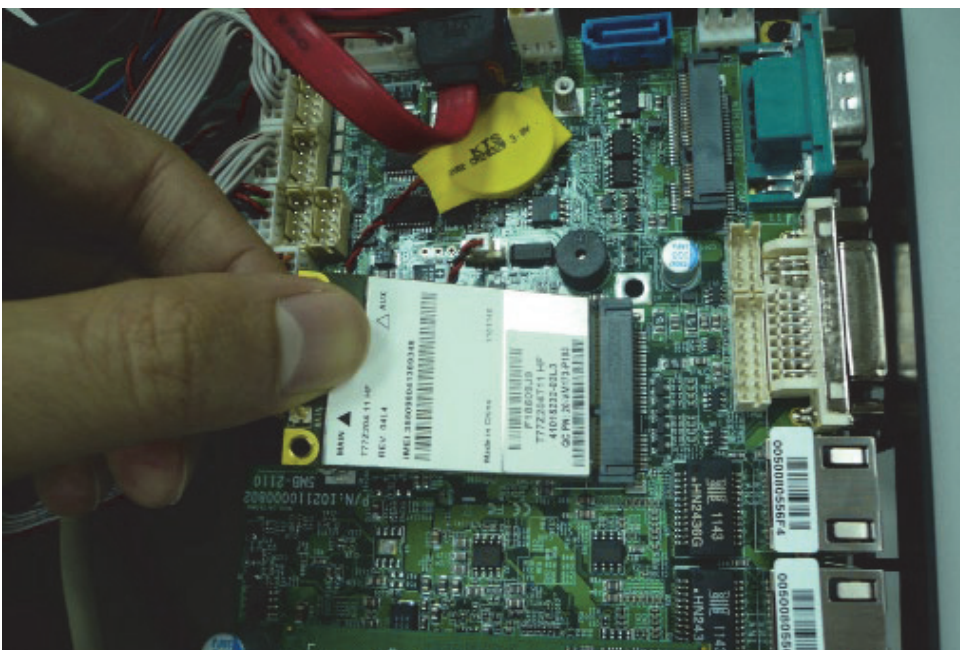

Step 3. Screw two screws to the holder as shown in the picture.



Step 4. Done as shown in the picture.



4.6 Installing MINI PCIe Expansion Card

Step 1. Put MINI PCIe Expansion Card on this place as shown in the picture.



Step 2. Hold the Module with its notch aligned with the socket of the board and insert it at a 30 degree angle into the socket as shown in the picture.



Step 3. Screw two screws to the holder as shown in the picture.



Step 4. Done as shown in the picture.



4.7 Installing SIM Card

Step 1. Use thin stick to push the button as shown in the picture.



Step 2. Take the holder away from front panel as shown in the picture.



Step 3. Put your SIM Card into the holder as shown in the picture.



Step 4. Take the SIM card holder and Insert it into the socket as shown in the picture.



Attention:

Please cut the main power when you insert the SIM.

Caution :

The SIM card will be not detected.

4.8 Installing Battery Module

Step 1. Screw two screws on the Back Cover as shown in the picture.



Step 2. Connect the Cable to UPS1 Connector as shown in the picture.

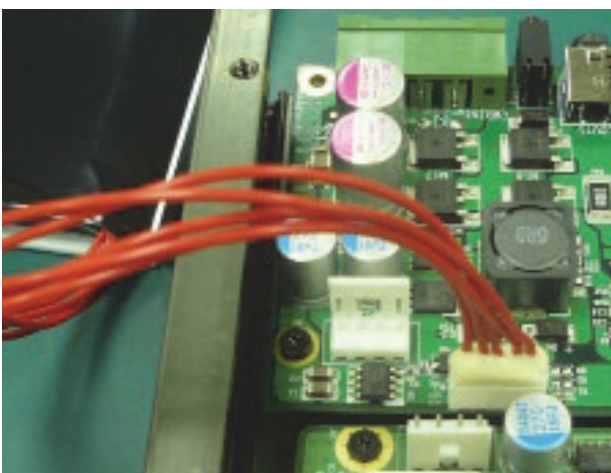

5.0 SYSTEM RESOURCE

5.0 SYSTEM RESOURCE

5.1 Ignition Power Management Quick Guide

Startup/shutdown conditions from the IGNITION signal:

- IGNITION startup signal must be valid during 5 sec. (anti noise protection).
- IGNITION shutdown – IGNITION signal must be inactive during 5 minutes, then PIC controller initiate Power Button signal (**OS must be set to shutdown from the Power Button**). It generate Main Button shutdown event and then goes to complete power off.

Typically the system can start only from IGNITION signal, because startup PIC controller is disconnected from the power source.

The system can be switched off from:

- Power IGNITION OFF signal.
- ACPI OS shutdown
- Power Button – generate ACPI event (OS dependent).

Power Ignition Startup Procedure

Power Ignition Shutdown Procedure

Power Management

- Power-off delay time is selectable by BIOS to disable and enable from 0-255 minutes (Default is 0 minutes)
- Ignition On/Off status detectable by SW
- If the ignition is off and the system is still on after 5 minutes, FleetPC-4-C will shut down automatically.
- If the ignition is turned on again and the power-off delay is in progress, FleetPC-4-C will cancel the delay function and will continue to operate normally.
- If the ignition is turned on again and the power-off delay ended, FleetPC-4-C will shut down completely will power-on again automatically.

6.0 BIOS

6.0 BIOS

6.1 Enter The BIOS

Power on the computer and the system will start POST (Power On Self Test) process. When the message below appears on the screen, press (DEL) key to enter Setup.

Press DEL to enter SETUP

If the message disappears before you respond and you still wish to enter Setup, restart the system by turning it OFF and On or pressing the RESET button. You may also restart the system by simultaneously pressing <Ctrl>, <Alt>, and <Delete> keys.

Important

- The items under each BIOS category described in this chapter are under continuous update for better system performance. Therefore, the description may be slightly different from the latest BIOS and should be held for reference only.
- Upon boot-up, the 1st line appearing after the memory count is the BIOS version. It is usually in the format.

FleetPC-4-C Mainboard V1.0 073109 where :

1st digit refers to BIOS maker as A = AMI, W = AWARD, and P = PHOENIX

2nd - 5th digit refers to the model number.

6th digit refers to the chipset as I = Intel, N = NVIDIA, A = AMD and V = VIA.

7th - 8th digit refers to the customer as MS = all standard customers.

V1.0 refers to the BIOS was released.

073109 refers to the date this BIOS was released.

Control Keys

Power on the computer and the system will start POST (Power On Self Test) process. When the message below appears on the screen, press (DEL) key to enter Setup.

<↑>	Move to the previous item
<↓>	Move to the next item
<←>	Move to the item in the left hand
<→>	Move to the item in the right hand
<Enter>	Select the item
<Esc>	Jumps to the Exit menu or returns to the main menu from a submenu
<+/PU>	Increase the numeric value or make changes
<-/PD>	Decrease the numeric value or make changes
<F1>	General Help
<F3>	Load Optimized Defaults
<F4>	Save all the CMOS changes and exit

Getting Help

After entering the Setup menu, the first menu you will see is the Main Menu.

Main Menu

The main menu lists the setup functions you can make changes to. You can use the arrow keys (↑↓) to select the item. The on-line description of the highlighted setup function is displayed at the bottom of the screen.

Sub-Menu

If you find a right pointer symbol (as shown in the right view) appears to the left of certain fields that means a sub-menu can be launched from this field. A sub-menu contains additional options for a field parameter. You can use arrow keys (↑↓) to highlight the field and press <Enter> to call up the sub-menu. Then you can use the control keys to enter values and move from field to field within a sub-menu. If you want to return to the main menu, just press the <Esc >.

General Help <F1>

The BIOS setup program provides a General Help screen. You can call up this screen from any menu by simply pressing <F1>. The Help screen lists the appropriate keys to use and the possible selections for the highlighted item. Press <Esc> to exit the Help screen.

6.2 Main

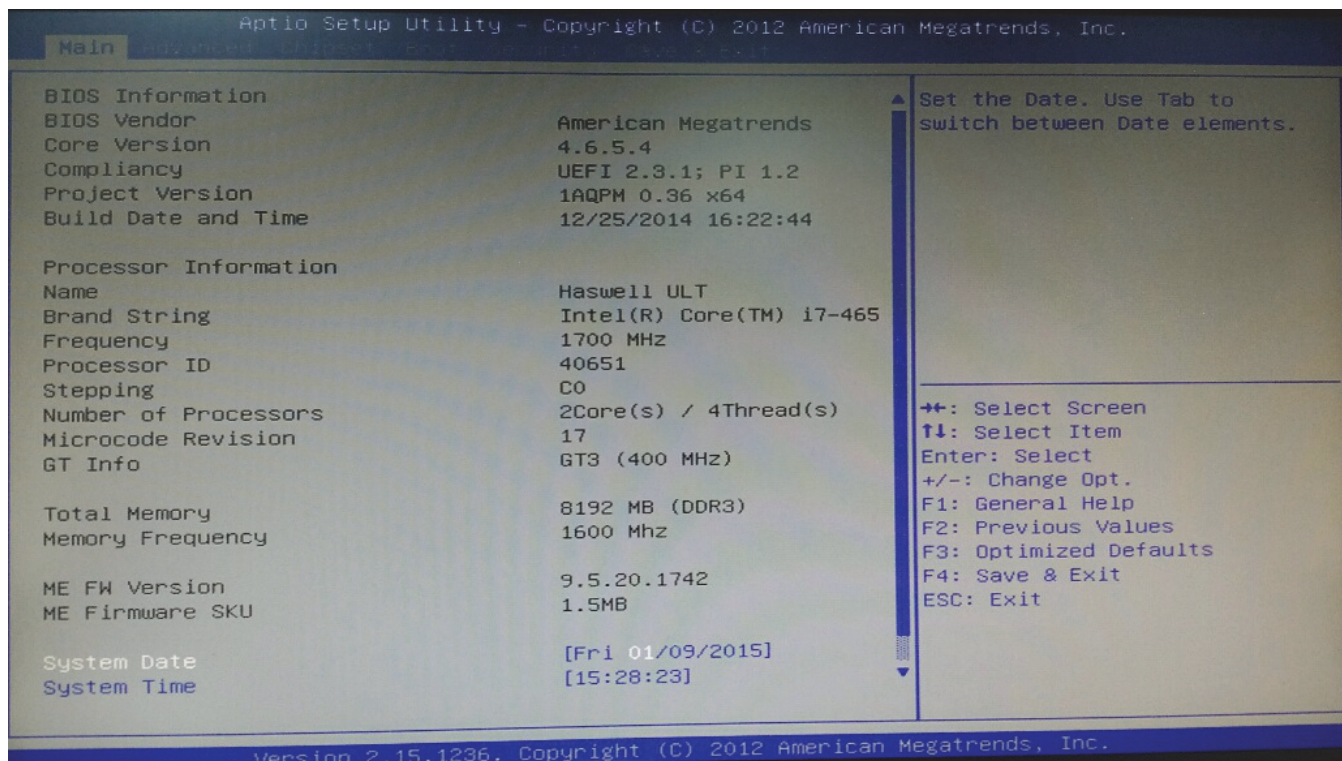

» System Date

This setting allows you to set the system Date. The time format is <Day> <Month> <Date> <Year>.

» System Time

This setting allows you to set the system time. The time format is <Hour> <Minute> <Second>.

6.3 Advanced

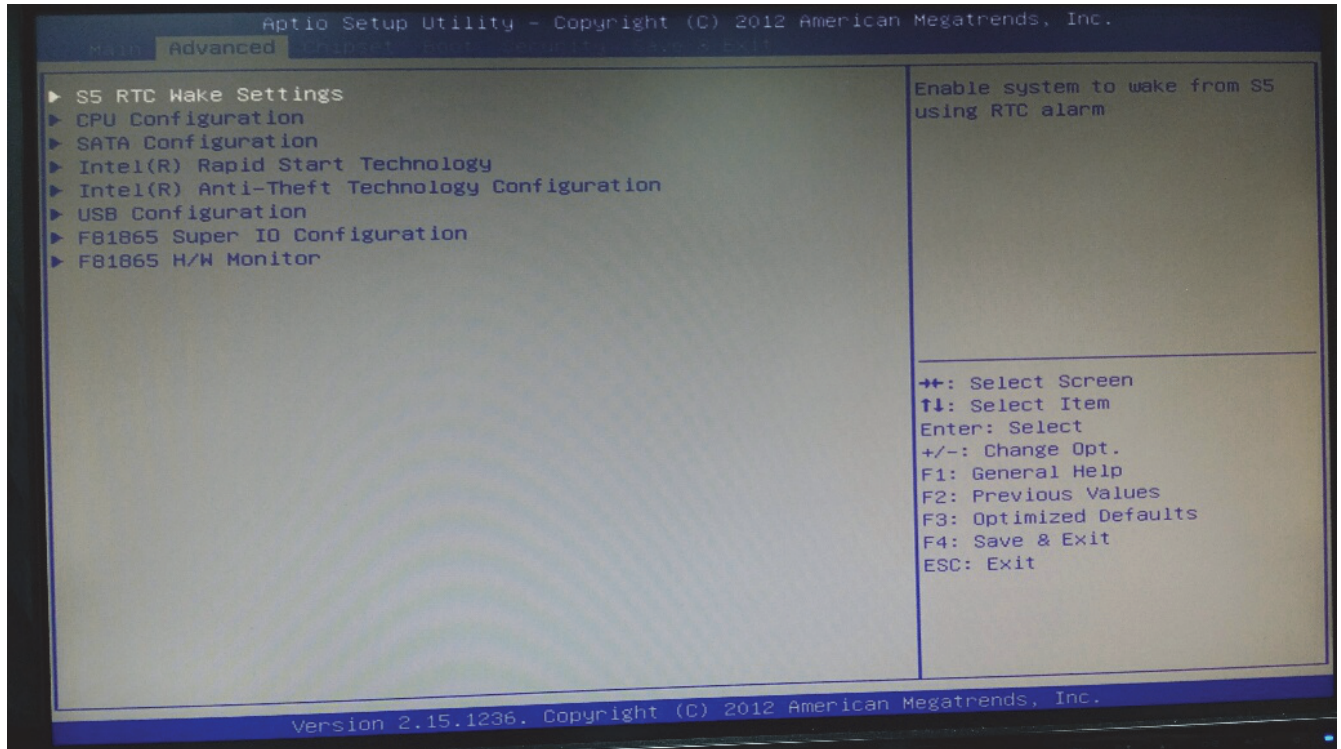

CPU Configuration

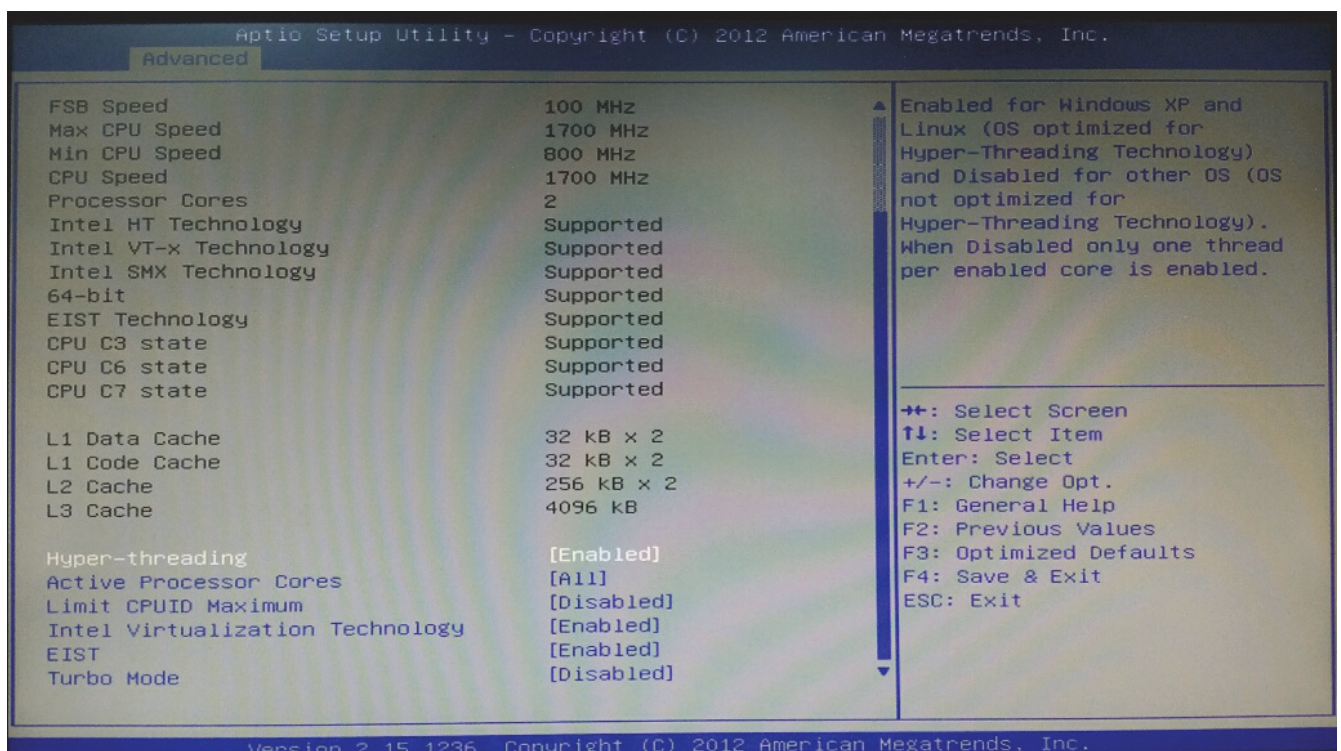

» Limit CPUID Maximum

The CPUID instruction of some newer CPUs will return a value greater than 3. The default is Disabled because this problem does not exist in the Windows series operating systems. If you are using an operating system other than Windows, this problem may occur. To avoid this problem, enable this field to limit the return value to 3 or less than 3.

» Intel Virtualization Technology

When this field is set to Enabled, the VMM can utilize the additional hardware capabilities provided by Vanderpool Technology.

» EIST

This field is used to enable or disable the Intel Enhanced SpeedStep Technology

Super IO Configuration

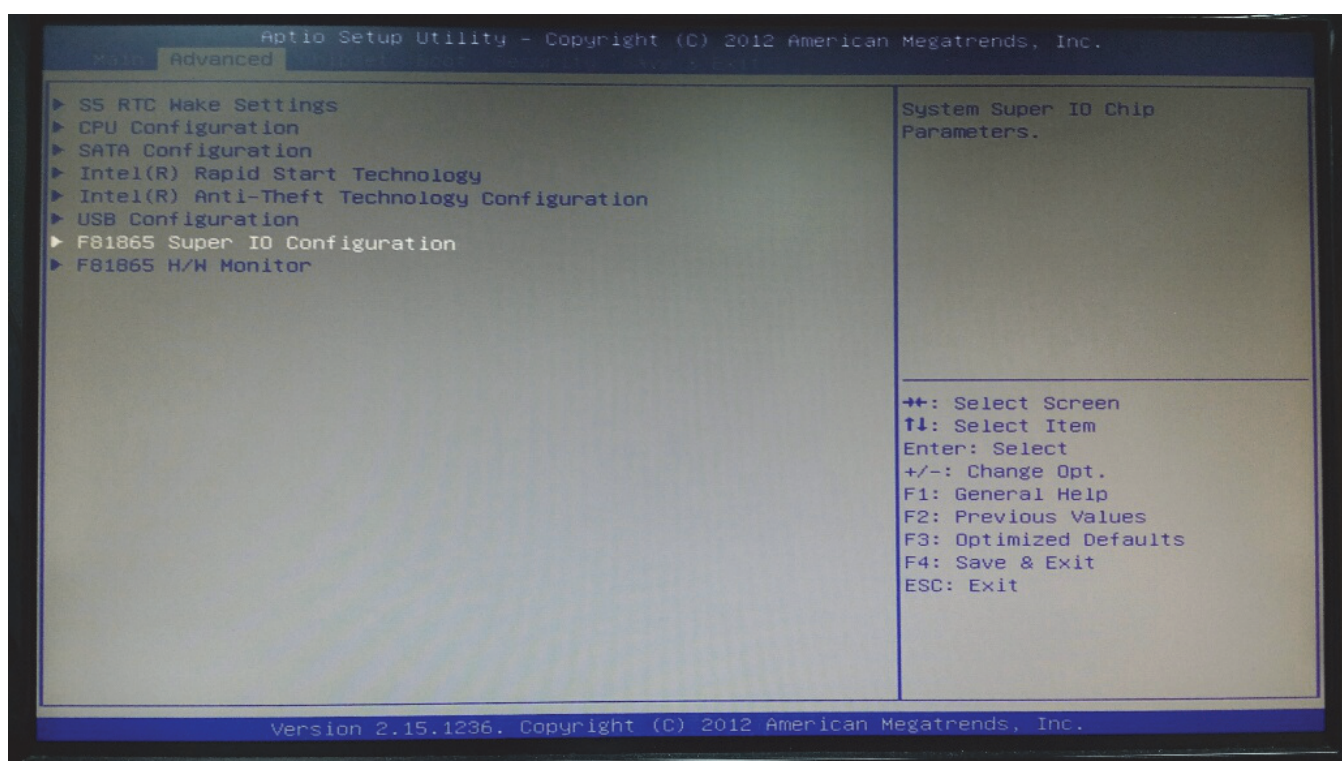
**» Serial Port 0/1/2/3 Enable or Disable**

Select an Enable or Disable for the specified serial ports.

» COM1 RS232/422/485 Select

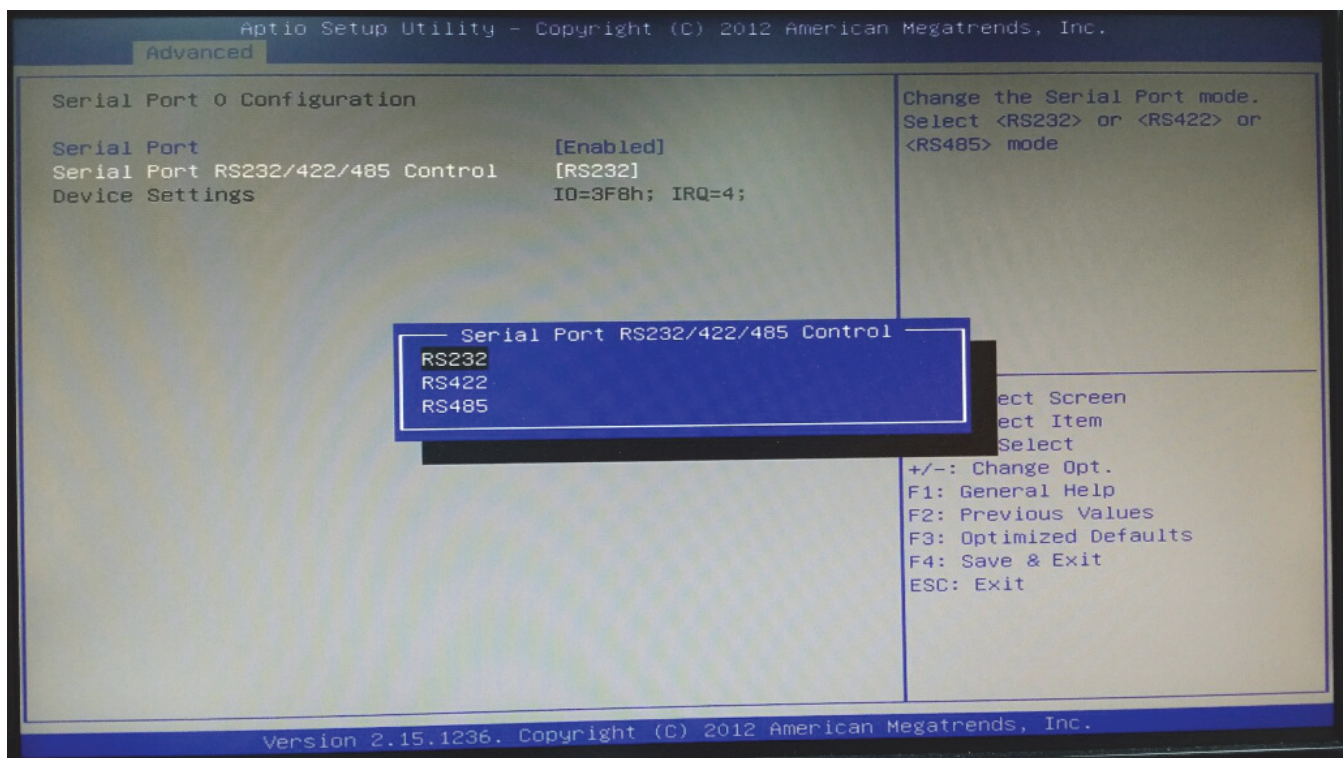
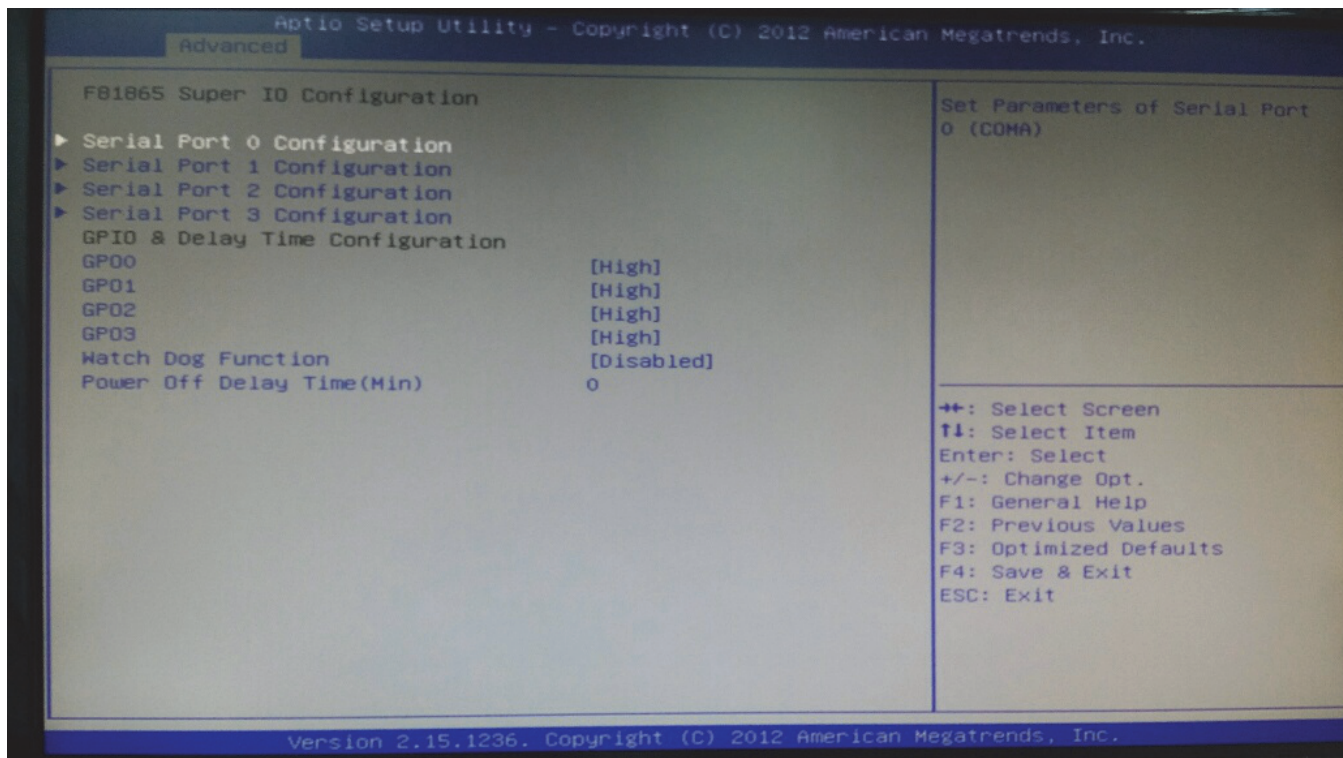

» COM2 RS232/422/485 Select

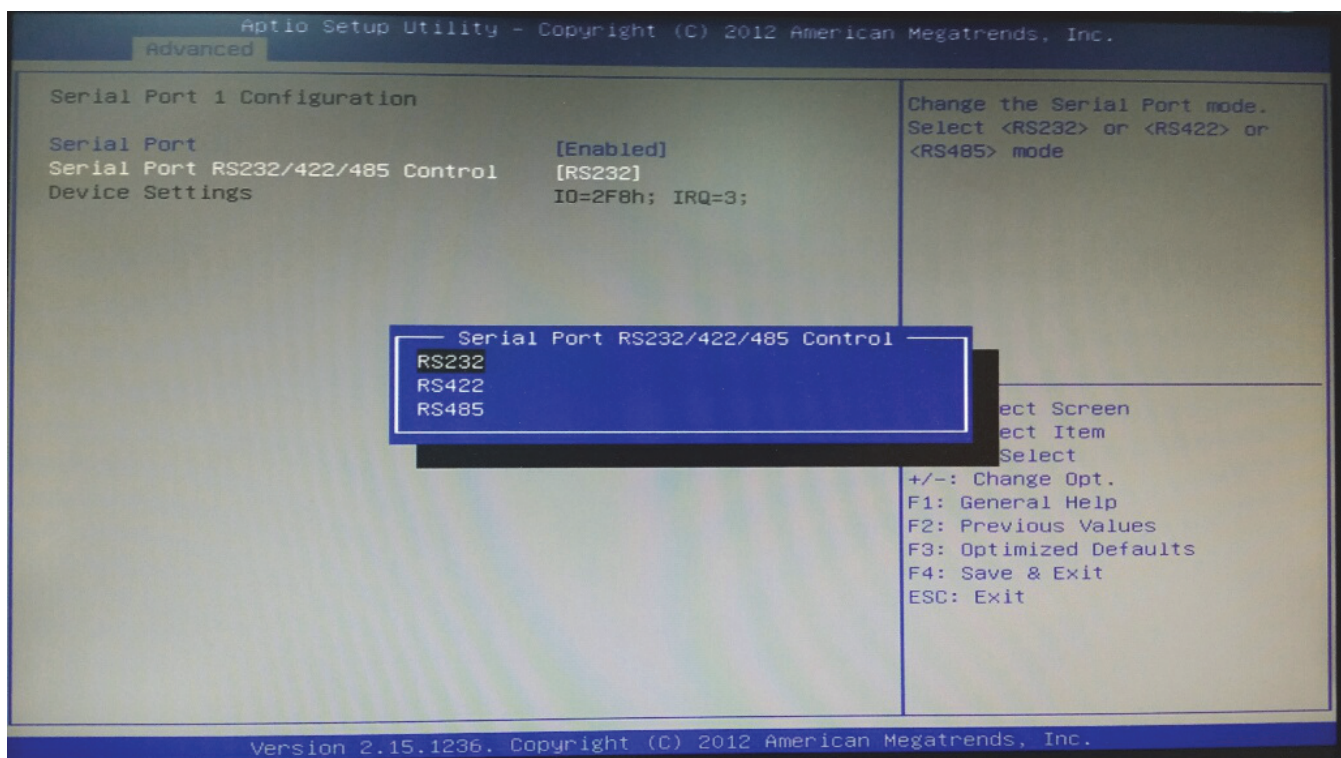
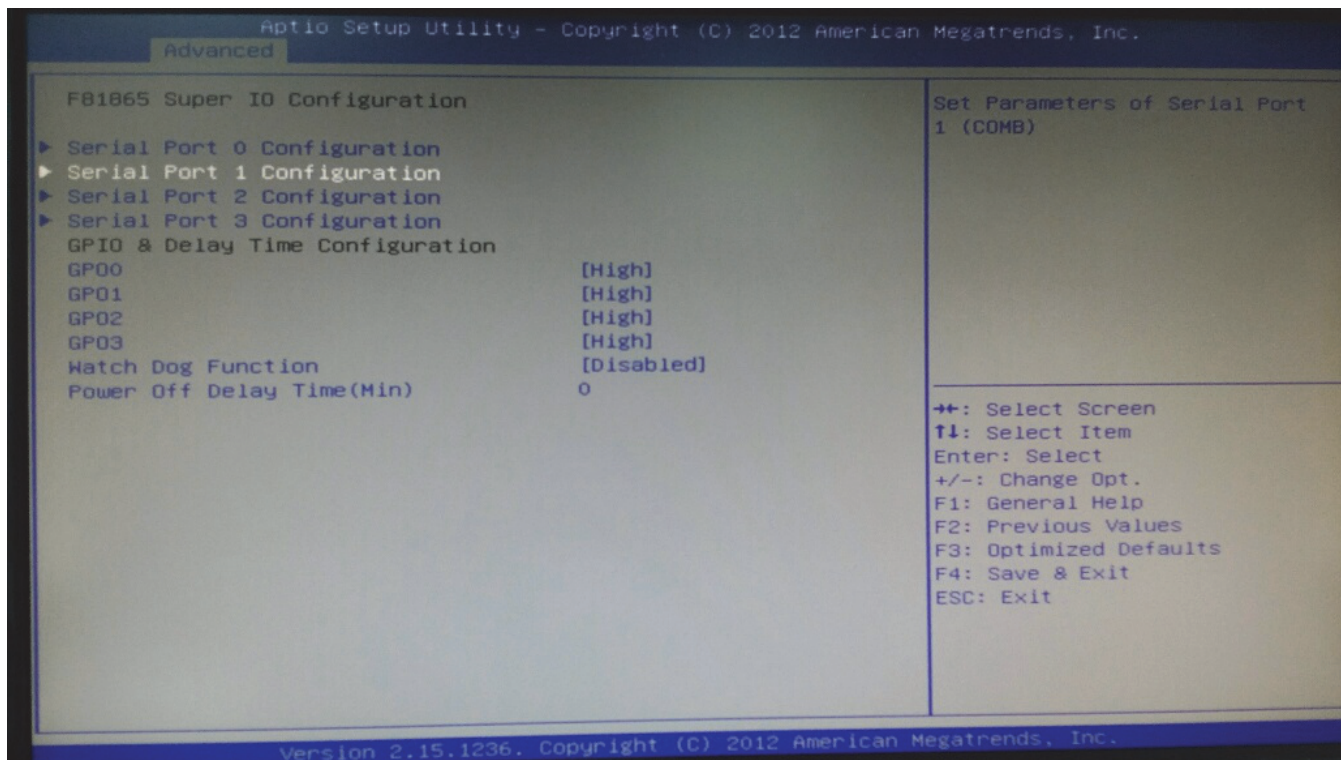

» Watch Dog Function

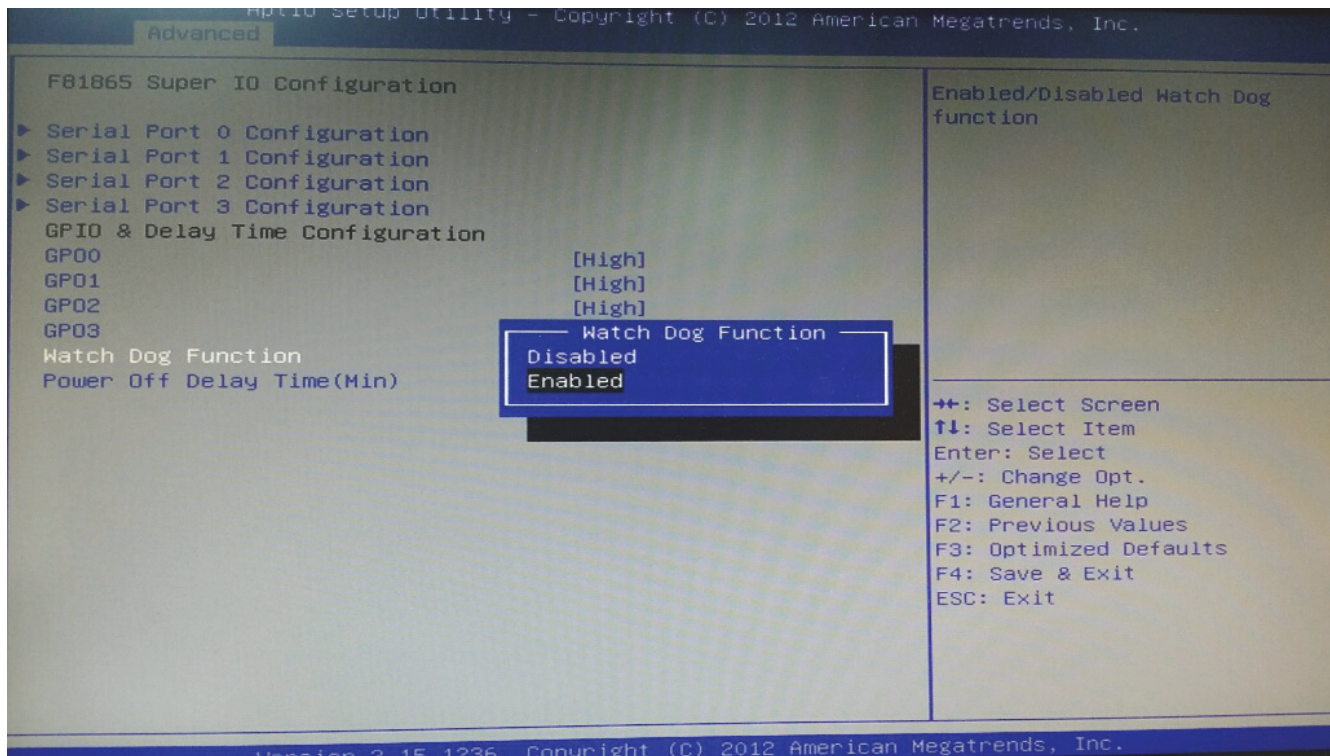

» Power off Delay Time Configuration

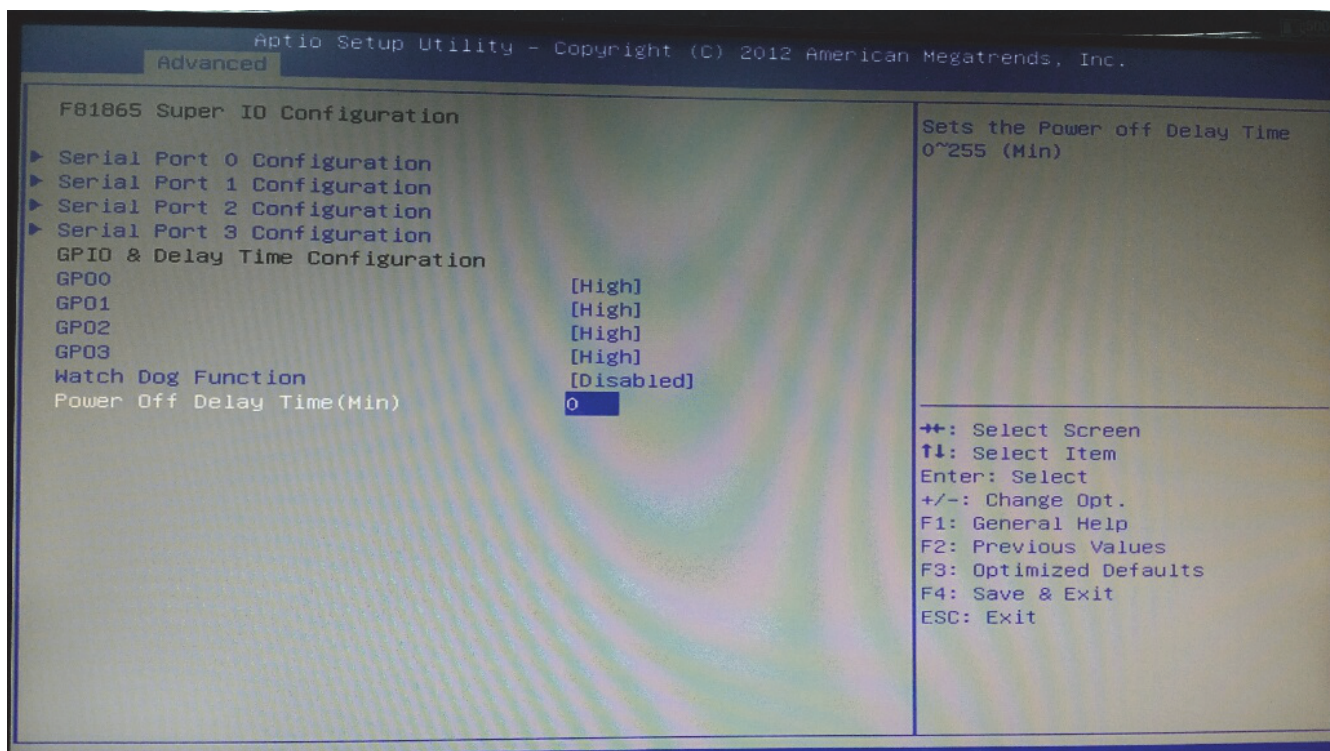

» GPO 0/ 1/ 2/ 3/ Data

These settings configure special GPIO data.

Hardware Health Configuration

These items display the current status of all monitored hardware devices/components such as voltages, temperatures and all fans' speeds.

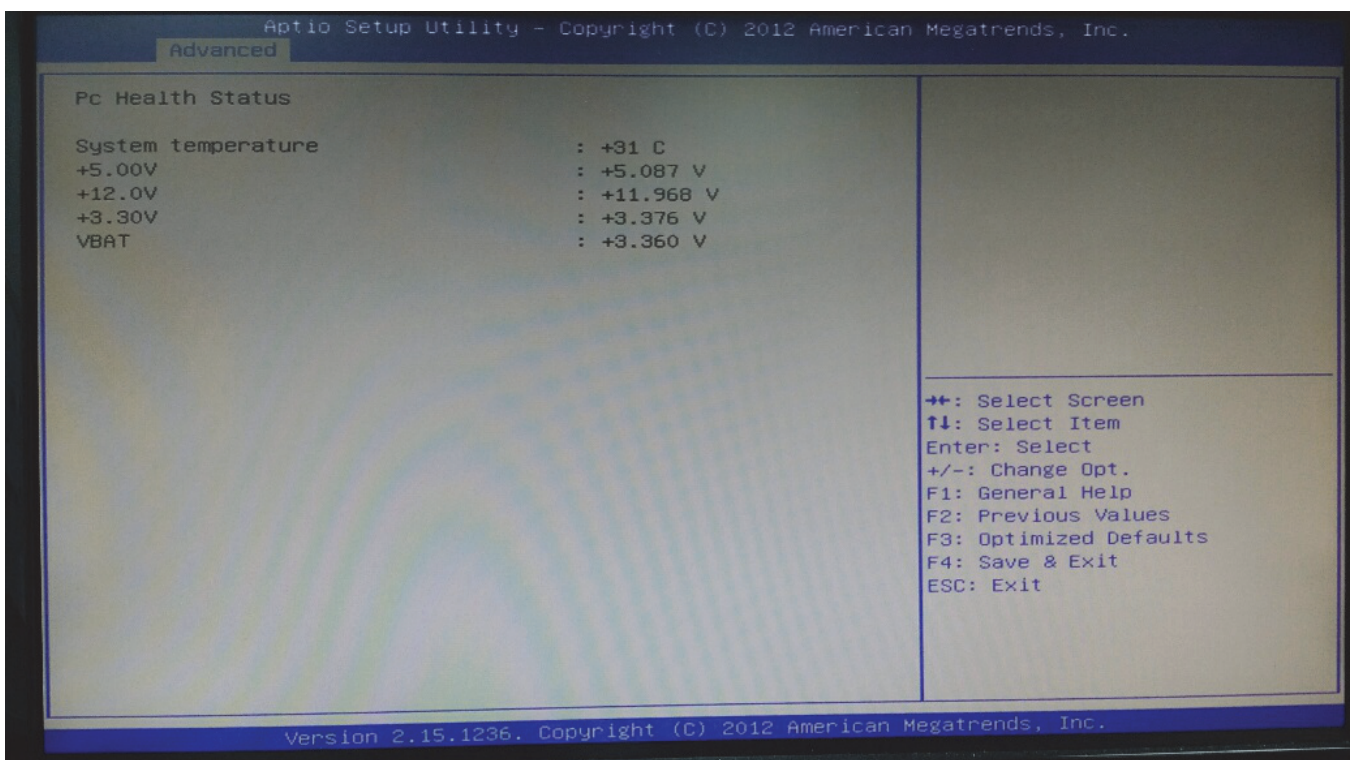

6.4 Chipset

PCH-IO Configuration

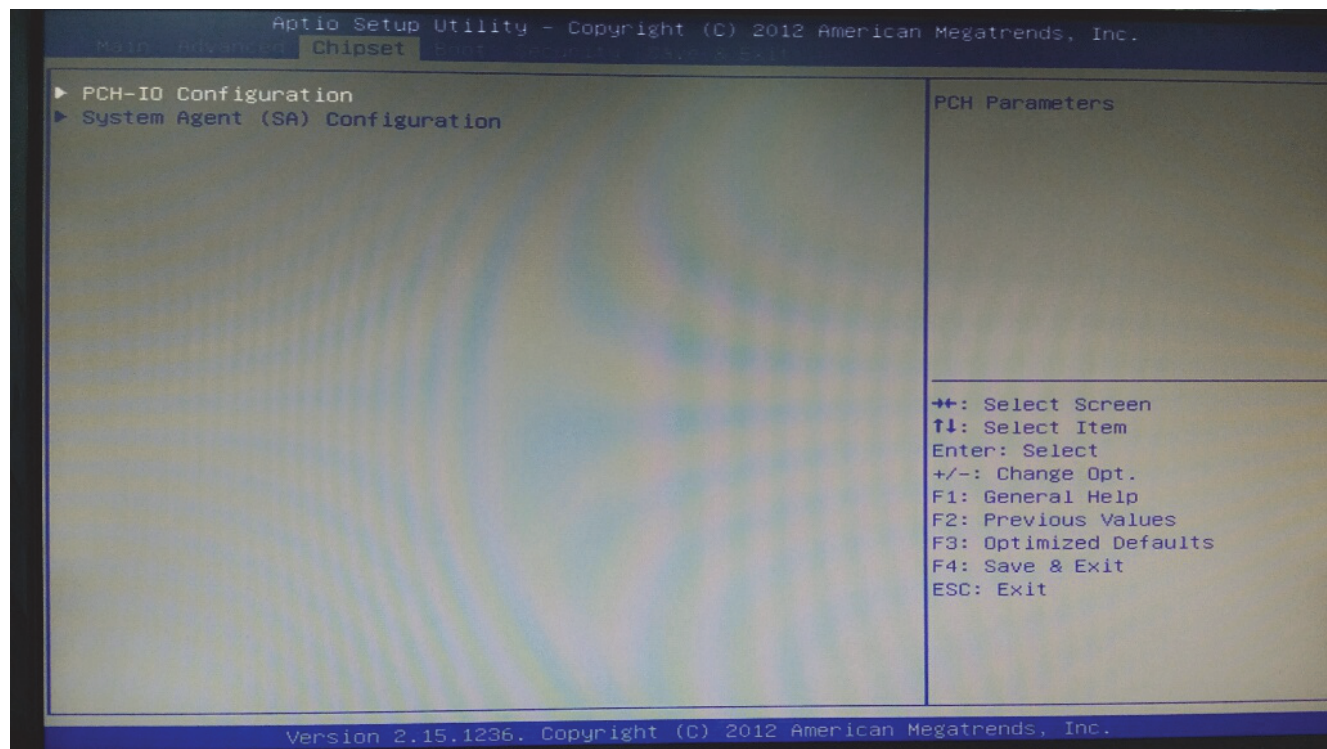

Restore AC Power Loss Configuration

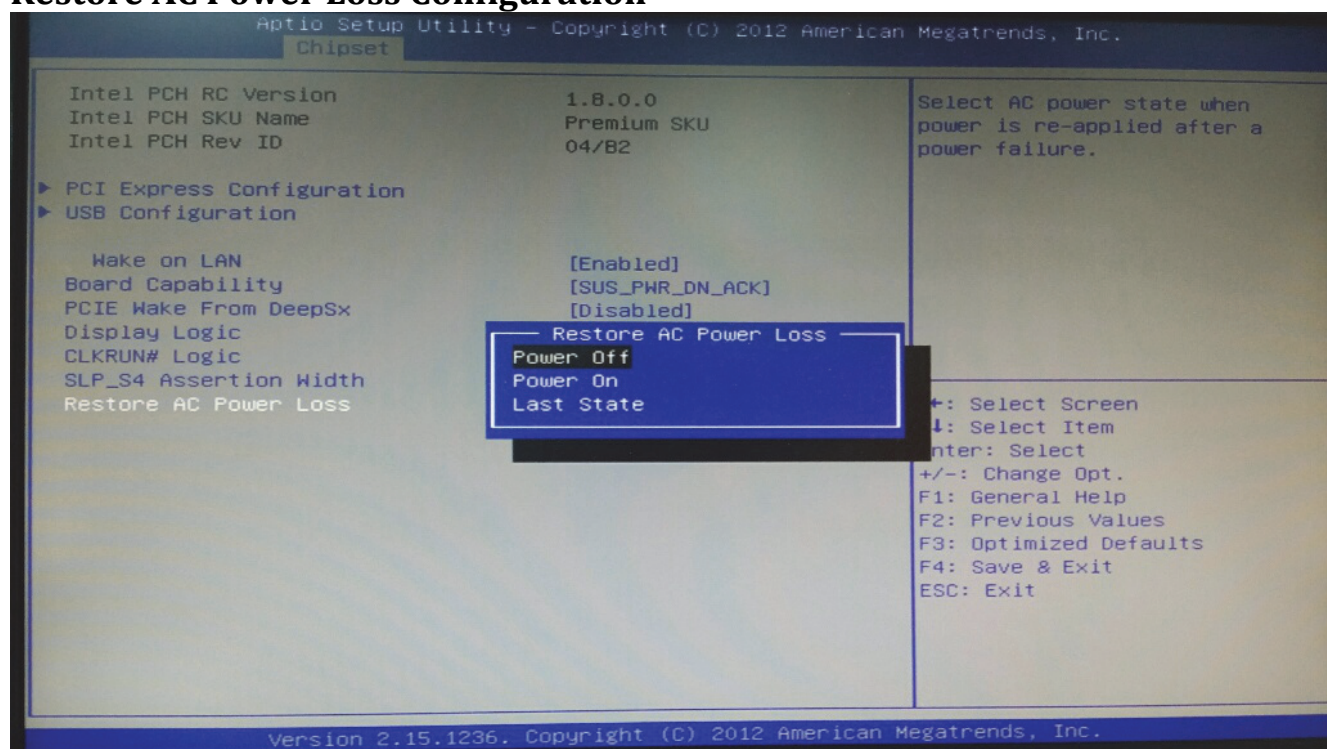

System Agent (SA) Configuration

» Graphics Configuration

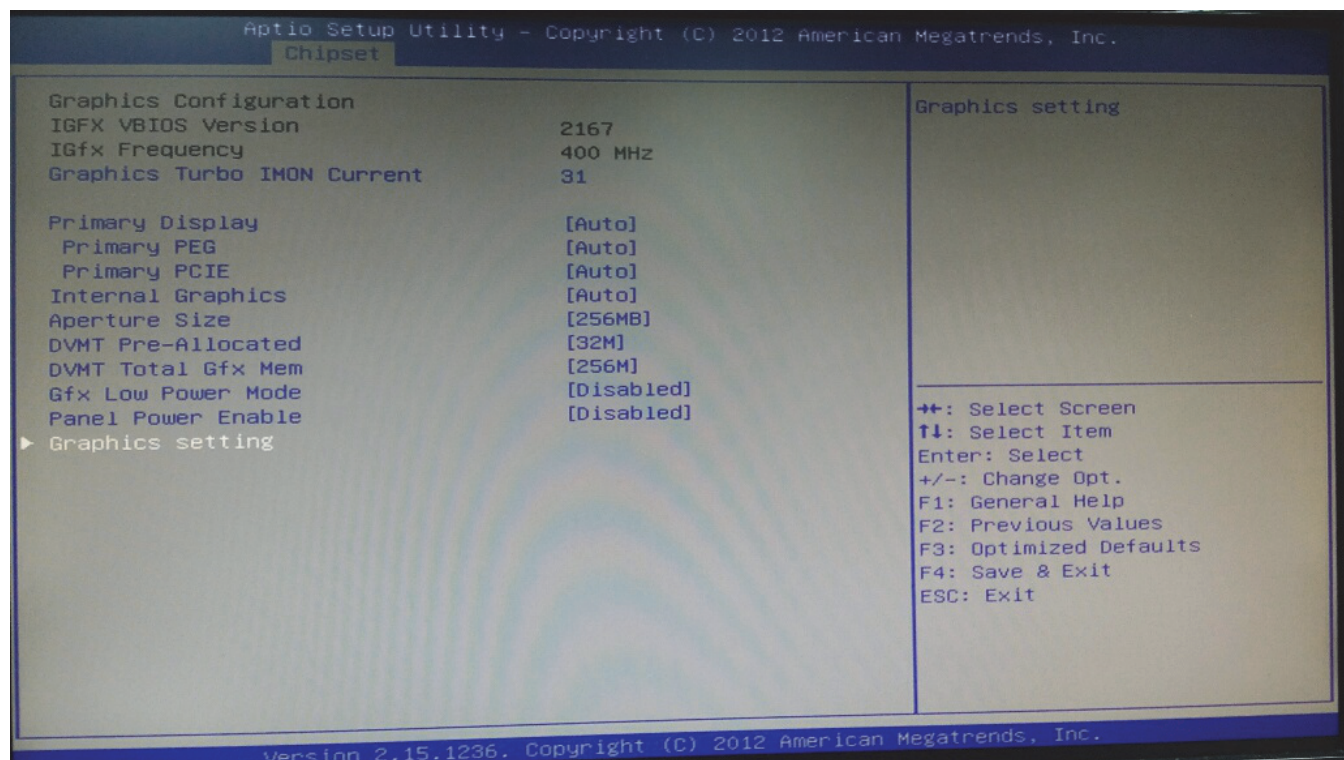
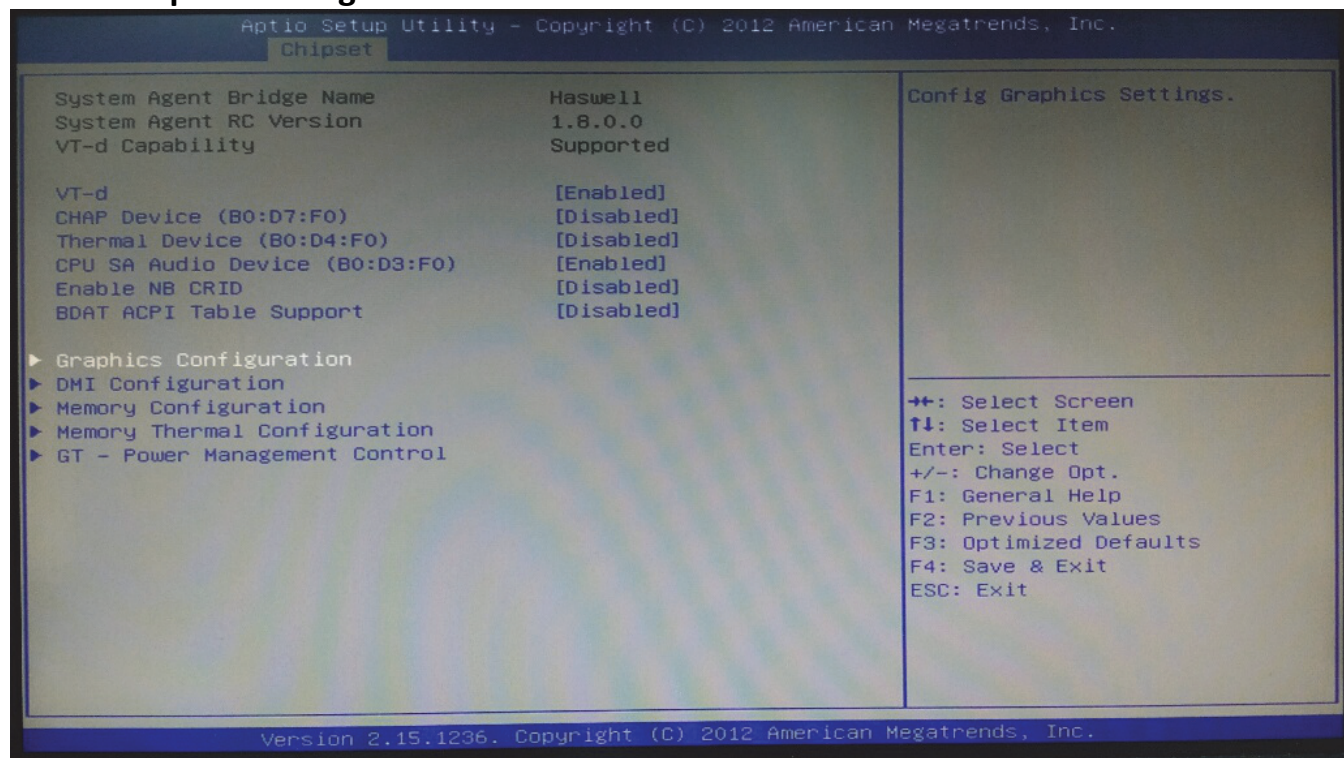

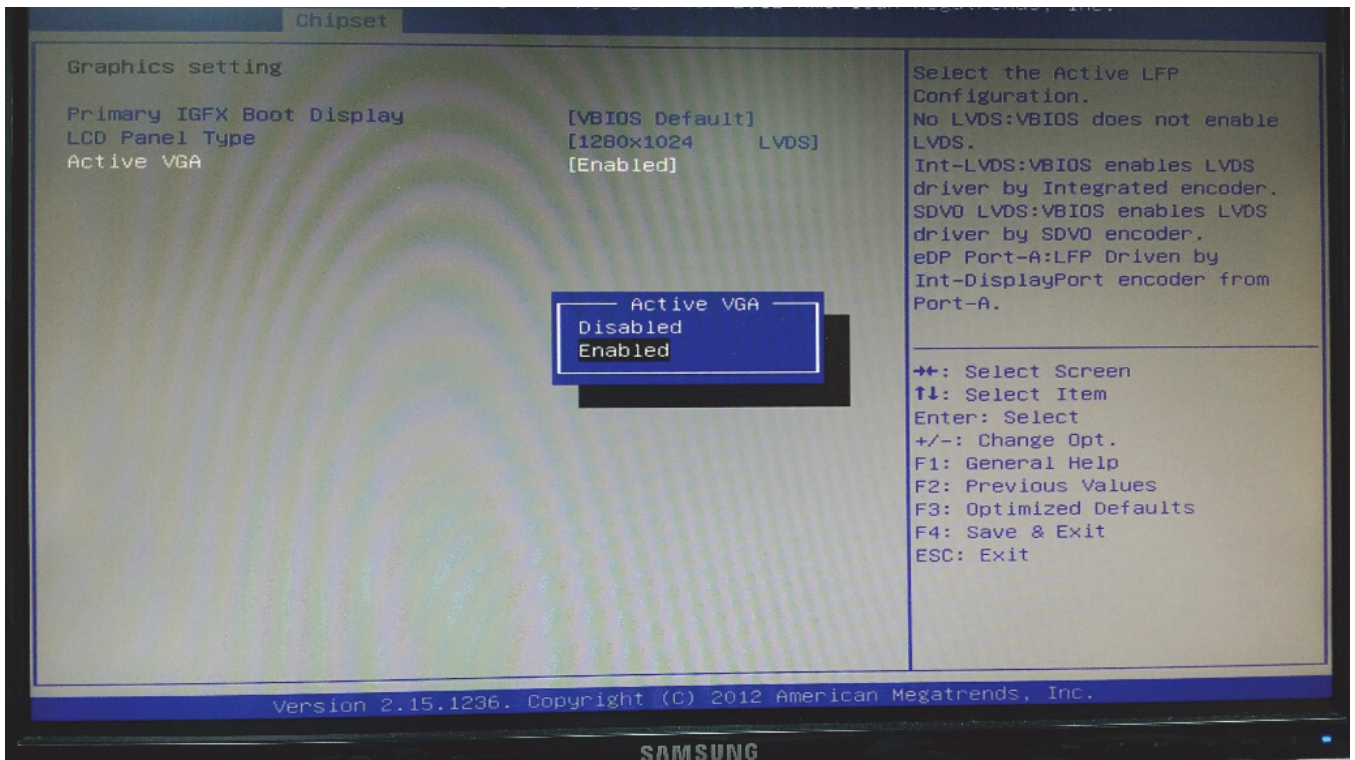

6.5 Boot

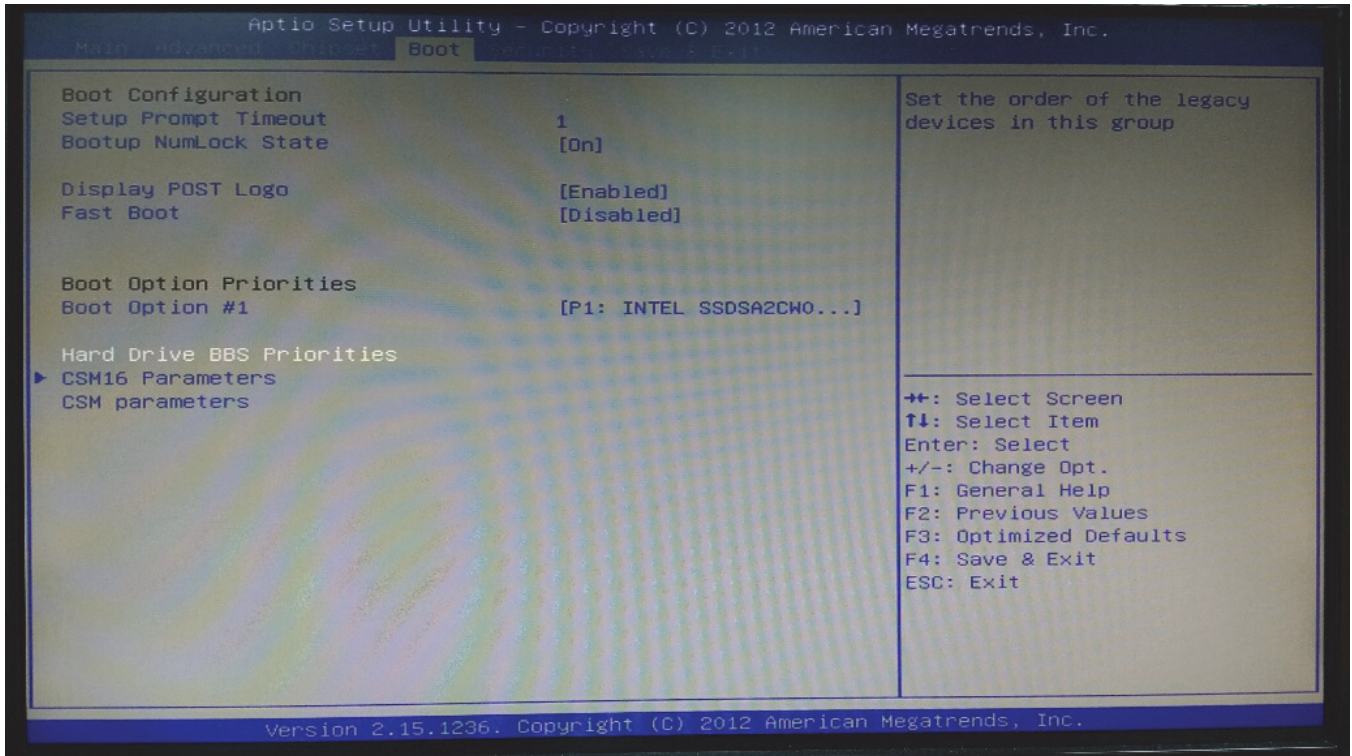

» 1st/2nd/3rd Boot Device

The items allow you to set the sequence of boot devices where BIOS attempts to load the disk operating system.

» Try Other Boot Devices

Setting the option to [Enabled] allows the system to try to boot from other device if the system fail to boot from the 1st/2nd/3rd boot device.

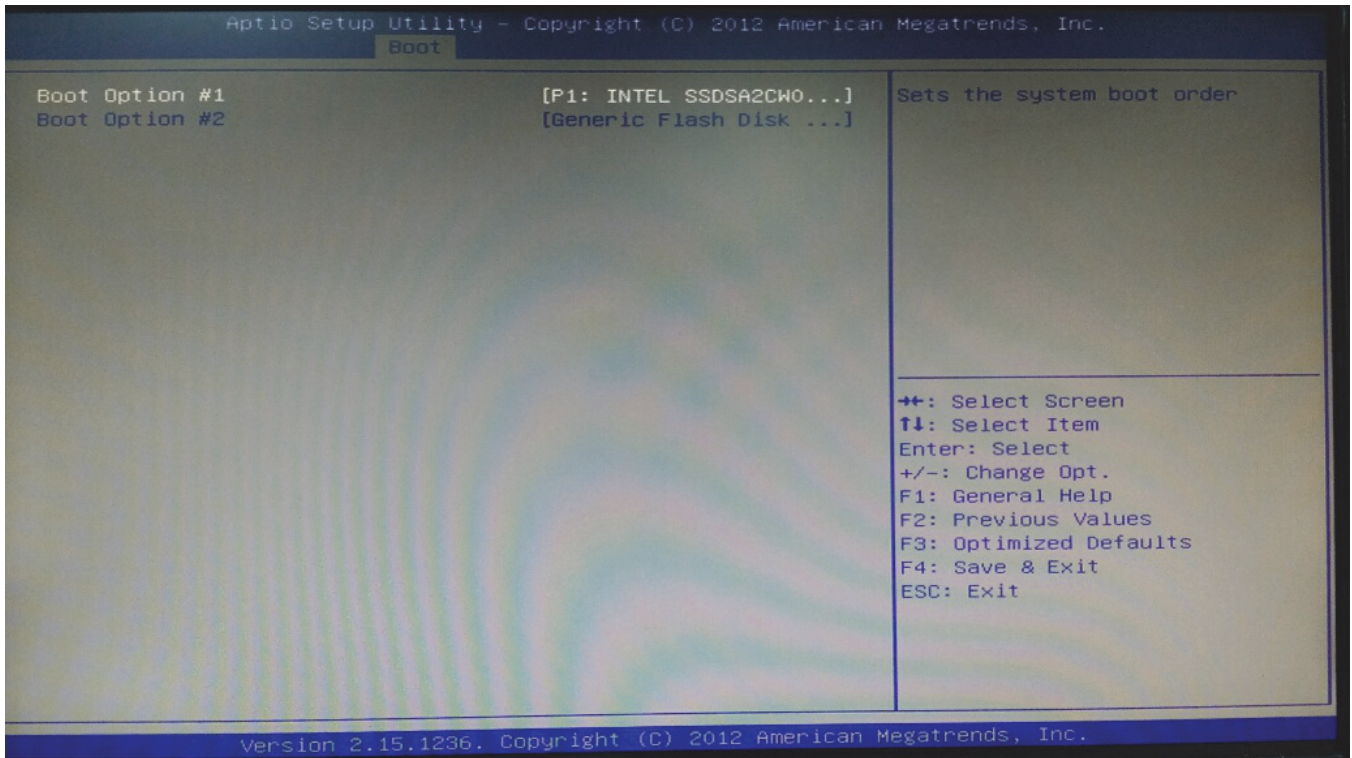

» Hard Disk Drives, CD/DVD Drives, USB Drives

These settings allow you to set the boot sequence of the specified devices.

6.6 Security

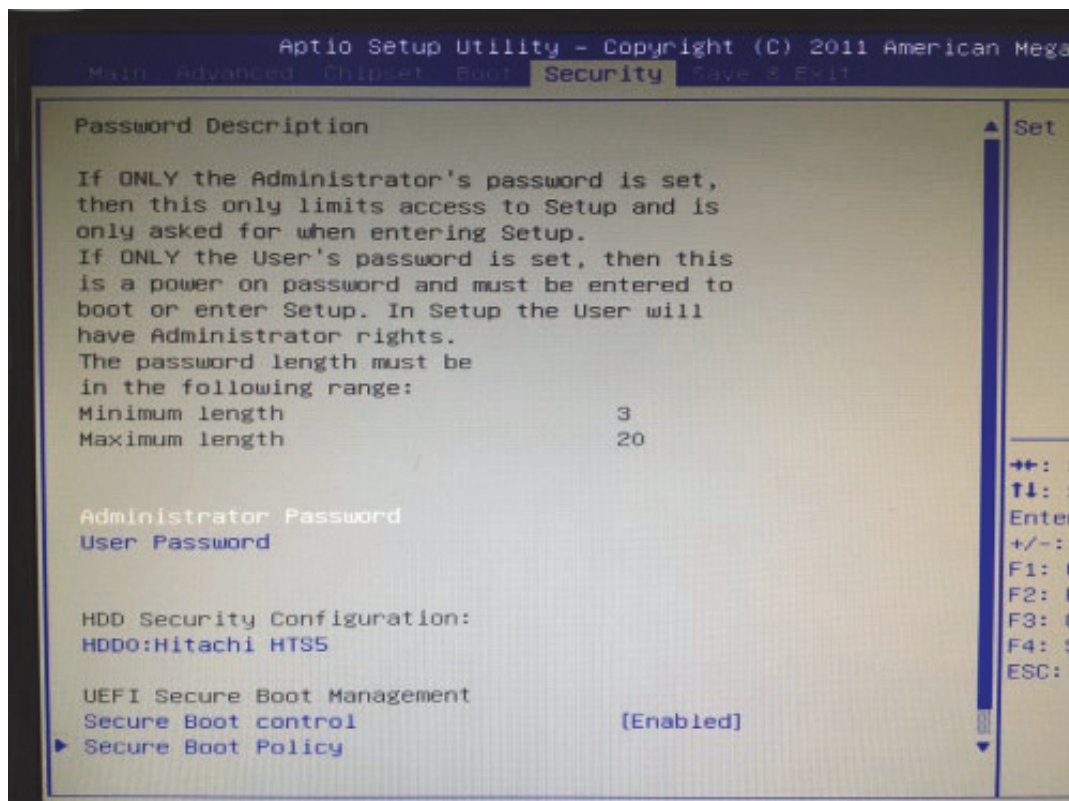

» Administrator Password

Administrator Password controls access to the BIOS Setup utility. These settings allow you to set or change the administrator password.

» User Password

User Password controls access to the system at boot. These settings allow you to set or change the user password.

» Boot Sector Virus Protection

This function protects the BIOS from accidental corruption by unauthorized users or computer viruses. When enabled, the BIOS data cannot be changed when attempting to update the BIOS with a Flash utility. To successfully update the BIOS, you will need to disable this Flash Protection function.

6.7 Exit

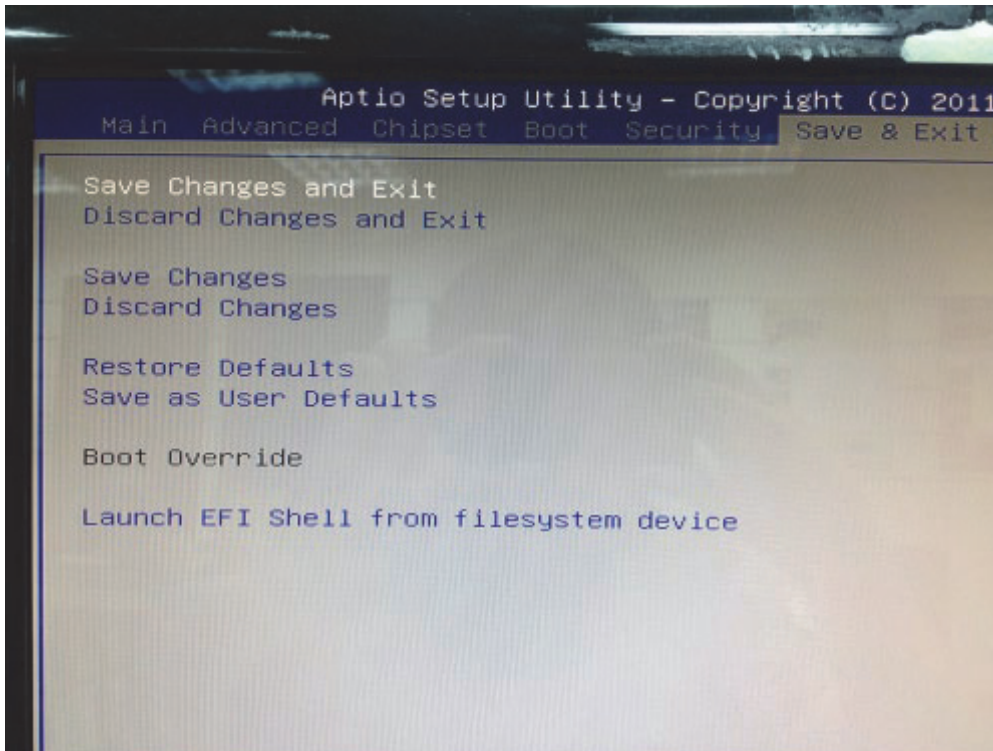

» Save Changes and Exit

Save changes to CMOS and exit the Setup Utility.

» Discard Changes and Exit

Abandon all changes and exit the Setup Utility.

» Discard Changes

Abandon all changes and continue with the Setup Utility.

» Load Optimal Defaults

Use this menu to load the default values set by the mainboard manufacturer specifically for optimal performance of the mainboard.

» Load Failsafe Defaults

Use this menu to load the default values set by the BIOS vendor for stable system performance

7.0 PACKING LIST

7.0 PACKING LIST

7.1 Packing List

System

Item	Part Number	Module Name
1	763120010000	FleetPC-4-C-C1 System
2	763120010001	FleetPC-4-C-i3 System

Accessory

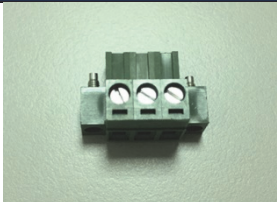
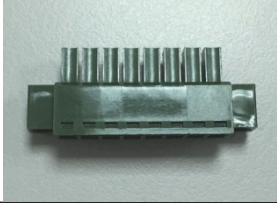
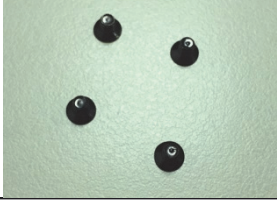
Picture	Part Number	Module Name	Q'ty
	326710039661	CABLING PHOENIX CON MALE 3PIN	1
	324610088661	CABLING PHOENIX CON MALE 8PIN	1
	351103040250	Screw F Type M3*4L ISO BK	4